

BRINDAMOS POR ELEGIRNOS!!!



50 años avalan la garantía de trabajo y honestidad.

Tratamos ante cualquier adversidad de mantener hasta el cansancio un trato cordial, amistoso y con respeto, tanto con clientes como proveedores y una atención, que al termino de cada encuentro o llamado telefónico, usted se vea favorecido por lo que usted nos vino haber o nos ha llamado.

Contamos con un fábrica de armado de máquinas y herramientas con una línea actualizada de producción superando la calidad de las herramientas importadas. Manteniendo stock de mercadería de reventa para la atención rápida de nuestros clientes mayoristas que atiende a sus clientes.

“Las gomerías y talleres de todo el país”

Enviamos mercadería a toda la República Argentina con rapidez y eficacia por el transporte que ha elección el cliente lo requiera.

Tenemos personal especializado en la reparación de todo tipo de maquinarias y herramientas que se utilizan en gomerías y talleres.

Mantenemos nuestro sitio web y un manual ilustrativo que entregamos a los clientes, para que sus vendedores muestren a sus clientes gomeros las novedades del rubro.

Solicite por correo electrónico la lista de precios actualizada con sus respectivos descuentos y posibles ofertas que mantendremos informado.

Carlos Ricardo Vivas  
Asesor Personal

Christian David Santangelo  
Gerente

# INDICE

ABRAZADERAS - ABRECUBIERTAS - ACEITERAS - ACEITES ACOPLES AUTOMÁTICOS	<b>1</b>
UNIÓN MANGUERA - REDUCCIÓN ROSCA MACHO - REDUCCIÓN ROSCA HEMBRA/MACHO - CUPLA REDUCCIÓN HEMBRA/HEMBRA CUPLA ROSCA HEMBRA/HEMBRA - ENTRE ROSCA MACHO/MACHO - ALARGUE DE GOMA - ALARGUE DE BRONCE - ALARGUE IMPORTADOS	<b>2</b>
ALINEACIÓN TELME - AMOLADORAS - ANTICORROSIVOS - ANTIPARRAS - AROS PARA LLANTAS - AROS O'RING - ASPIRADORA - BAJA TALONES - BALANCEADORAS	<b>3</b>
BANCO PARA DESARME DE MOTOR - BATEAS - CAMILLA - CÁMARAS COCHES PICKUP Y CAMIÓN CÁMARAS PARA CICLOMOTOR - CAÑOS DE GOMA - PVC - ESPIRALADO PARA COMPRESOR	<b>4</b>
CARGADOR DE BATERÍAS - CARRETELES RETRÁCTILES - CEPILLOS - CEPILLOS LAVADERO - COMPUESTOS CUCHILLOS - COMPRESORES CON MOTOR	<b>5</b>
REPUESTOS PARA COMPRESORES	<b>6</b>
CONTRAPESOS	<b>7</b>
CRIQUE CAJA DIFERENCIAL CARRO - CRIQUE BOTELLA HIDRÁULICO - CRIQUE BOTELLA CON TORNILLO CRIQUE BOTELLA TELESCOPICO - CRIQUE BOTELLA HIDRONEUMÁTICO - CRIQUE BOTELLA HIDRONEUMÁTICO COLECTIVO - CRIQUE BOTELLA CARRO HIDRONEUMÁTICO - CRIQUE CARRO HIDRÁULICO - CRIQUE PORTATIL	<b>8</b>
REPUESTOS CRIQUE CARRO - DESARMADORAS	<b>9</b>
DESARMADORAS - DESMOLDANTES - DISYUNTORES	<b>10</b>
EXPANSOR HIDRÁULICO - ELEVADORES - ENGRASADORAS - FILTROS - FLUX - FRANELA -GOMITAS	<b>11</b>
GRABADORAS - GUANTES - GUINCHES - HIDROLAVADORAS - INTERIORES - INFLADORES - LEZNA Y LIMA LIMPIA MANOS GEL - LLAVE CRIQUE	<b>12</b>
LLAVES CRUZ - LLAVES TUBO - LLAVES AFLOJA TUERCA CAMIÓN Y VIAL - MANDRILES - MANGUERA ENGRASE ALTA PRESIÓN	<b>13</b>
MANGUERA ENGRASE MEDIA PRESIÓN - MANÓMETRO PARA COMPRESOR - MARTILLOS - MAZAS - MORSAS - MOTORES MONOFÁSICOS - MOTORES TRIFÁSICOS - MEDIDORES DE COMODÍN Y VARIOS	<b>14</b>
MEDIDORES DE COMODÍN Y VARIOS - NUMERADOR - PALANCAS NACIONALES E IMPORTADAS	<b>15</b>
PASANTE DE FUERZA - PASTA LUBRICANTE - PICOS DESINFLA INFLA CÁMARA - PICOS ENGRASE - PIEDRAS PINCELES PARA LUX	<b>16</b>
PINZAS DE CONTRAPESOS - PISTOLAS DE DESEMPOLVAR Y OTRAS - PISTOLAS DE IMPACTO NEUMÁTICAS	<b>17</b>
PRECINTOS DE PLÁSTICO - PRENSA DE PIE Y BANCO - PRENSA ESPIRALES NEUMÁTICA Y MANUALES	<b>18</b>
PROTECTORES - PULIDORAS - RACCORDS	<b>19</b>
RASPAS CIRCULARES - RASPAS CUCHILLAS - RASPAS PLOMO - RASPAS TUNGSTENO	<b>20</b>
RESISTENCIAS - RODILLOS - SACA FILTRO - SEPARADORES - SOLDADORAS ELÉCTRICAS	<b>21</b>
SOLDADORAS MIG MAG - SOPORTE CHASIS - SUPLEMENTOS PARA ALINEACIÓN - TALCO - TANQUE PORTATIL	<b>22</b>
TAPITAS - TELACORD - TERMINALES PARA CAÑOS ESPIRALADOS - TERRAJAS - TIJERAS - TIZAS - TRABA CUBIERTA - TRAPOS REJILLA	<b>23</b>
TUBOS IMPACTO ½ - TUBOS IMPACTO 3/4 - TUBOS IMPACTO 1" - VÁLVULA MOTO COCHE CAMIONETA CAMIÓN - VÁLVULA CAMIÓN DE BRONCE CON CÁMARA - VÁLVULA DE BICICLETA	<b>24</b>
VÁLVULA SCOOTER COCHE CAMIONETA DE GOMA P/CUBIERTA SIN CÁMARA - VÁLVULA CAMIONETA CAMIÓN COLECTIVOS - VÁLVULA DE TRACTOR - VÁLVULA Y REPUESTOS VIALES - VÁLVULA ENVELOPE	<b>25</b>
VULCANIZACIÓN SAFETY SEAL - VULCANIZADORAS	<b>26</b>
PARCHES MANCHONES PARA CUBIERTAS LÍNEA RC	<b>27</b>
<b>PARCHES TG - PARCHES PRECUREX</b>	<b>28 - 29 - 30 - 31</b>
HERRAMIENTAS ESPECIALES	<b>32 - 33 - 34 - 35</b>

**CODIGO**
**DESCRIPCION**
**ABRAZADERAS**

101001	A Cremallera 8/12 (ancho 7mm.) PERFECTO
101002	A Cremallera 8/16 (ancho 9mm) PERFECTO
101003	A Cremallera 10/22 (ancho 9mm)

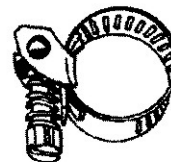
**ABRECUBIERTAS**

105009	Abrecubierta horizontal camilla
105010	Abrecubierta horizontal rural

**105011 Abrecubierta de camión con elevador**
**REPUESTOS**

105019	Resorte abre cubierta camilla
105020	Válvula entrada/salida RR-EDB
105022	Sopapa tipo aro RR-EDB
105023	Sopapa ciega tipo SSC

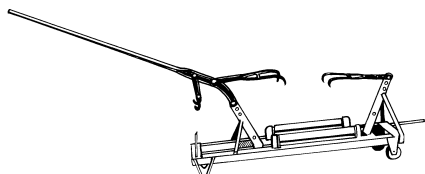
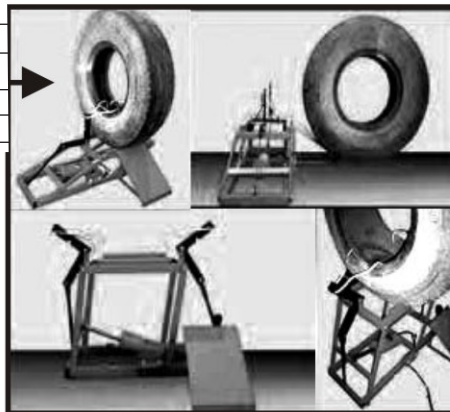
**ACEITERAS**

110002	Aceitera metálica pico flexible 240 cc
110003	Aceitera metálica pico flexible 475 cc

**ACEITES**

114001	Aceite hidráulico 1L.
114002	Aceite neumático 1L.

**ACOPLES AUTOMATICOS**

119001	ACOPLE AUTOMATICO DE 1/4 REFORZADO MM
119002	Acople TIPO ARO automático 1/4 AL
119003	Acople automático de 1/4 de bronce
119004	Acople automático 3/8 (sin puntas)
119005	Acople automático 1/2 (sin puntas)

**REPUESTOS 1/4 para acoples**

119010	Enchufe 1/4 rosca macho 1/4
119011	Enchufe 1/4 rosca hembra 1/4
119012	Enchufe 1/4 manguera 1/4
119013	Rosca 1/4 macho-manguera 1/4
119014	Rosca 1/4 hembra-manguera 1/4
119020	Acople de 1/4 para raccord dual de hierro
119021	Acople para raspa cónica

**REPUESTOS 3/8 para acoples**

119035	Enchufe 3/8 rosca macho 3/8
119036	Enchufe 3/8 rosca hembra 3/8
119037	Enchufe 3/8 manguera 3/8
119038	Rosca 3/8 macho-manguera 3/8

**REPUESTOS 1/2 para acople**

119051	Enchufe 1/2 rosca macho 1/2
119052	Enchufe 1/2 rosca hembra 1/2
119053	Enchufe 1/2 manguera 1/2

**REPUESTOS MEDIDAS COMBINADAS PARA ACOPLES**

119062	Enchufe 1/4 manguera 5/16
119063	Enchufe 1/4 manguera 3/8
119064	Enchufe 1/4 manguera 1/2
119065	Rosca macho 1/4 manguera 5/16
119066	Rosca-macho 1/4 manguera 3/8
119067	Rosca-macho 1/4 manguera 1/2
119068	Rosca-hembra 1/4 manguera 5/16
119069	Rosca-hembra 1/4 manguera 3/8
119070	Rosca-hembra 1/4 manguera 1/2
119071	Rosca-macho 1/2 manguera 1/4
119073	Enchufe 3/8 rosca macho 1/4



**CODIGO**
**DESCRIPCION**
**UNION MANGUERA**

119080	Unión manguera 1/4
119081	Unión manguera 5/16
119082	Unión manguera 3/8
119083	Unión manguera 1/2
119084	Unión manguera TEE 1/4
119085	Unión manguera TEE 5/16
119086	Unión manguera TEE 3/8
119087	Unión manguera TEE 1/2

**REDUCCION ROSCA MACHO**

119101	Reducción rosca macho 1/4x3/8
119102	Reducción rosca macho 3/8x1/2
119103	Reducción rosca macho 1/4x1/2

**REDUCCION ROSCA HEMBRA/MACHO**

119111	Reducc. rosca hembra/macho 1/4x1/2
119112	Reducc. rosca hembra/macho 1/8 x1/4
119113	Reducc. rosca hembra/macho 3/8x1/4
119114	Reducc. rosca hembra/macho 1/2x3/8
119115	Reducc. rosca hembra/macho 1/2x1/4
119116	Reducc. rosca hembra/macho 1/4x1/8

**CUPLA REDUCCION HEMBRA/HEMBRA**

119141	Cupla reduc. hembra 3/8 hembra 1/4
119142	Cupla reduc. hembra 1/2 hembra 3/8
119143	Cupla reduc. hembra 1/2 hembra 1/4
119144	Cupla reduc. hembra 1/4 hembra 1/8

**CUPLA ROSCA HEMBRA/HEMBRA**

119151	Cupla hembra-hembra 1/4
119152	Cupla hembra-hembra 3/8
119153	Cupla hembra-hembra 1/2

**ENTRE ROSCA MACHO/MACHO**

119161	Entre rosca macho/macho 1/4x1/4
119162	Entre rosca macho/macho 3/8x3/8
119163	Entre rosca macho/macho 1/8x1/8
119164	Entre rosca macho/macho 1/2x1/2

**ALARGUE DE GOMA**

124001	Alargue goma 12 cms.
124002	Alargue goma 20 cms.
124003	Alargue goma 30 cms.

**ALARGUE DE BRONCE**

128001	Alargue bronce con ovulo incorporado 70 mm.
128002	Alargue bronce con ovulo incorporado 115 mm.
128003	Alargue bronce con ovulo incorporado 150 mm.
128004	Alargue bronce con ovulo incorporado 170 mm.
128011	Alargue bronce 60 mm. MH
128012	Alargue bronce 100 mm. MH
128013	Alargue bronce 120 mm. MH

**ALARGUE IMPORTADOS**

128018	Alargue 210 mm. c/suj.chapa tipo SCHRADER
128019	Alargue 270 mm. c/suj.chapa tipo SCHRADER
128041	Sujetador p/alargue doble
128042	Sujetador p/alargue 16 mm.



**CODIGO**

**DESCRIPCION**

**ALINEADORAS TELME**

132002	Laser coche/pickup L4000/01
132003	Laser coche/pickup p/elev. L4000/01/07
132005	Laser coche/pickup p/elev./fosa L400



**AMOLADORAS especial para gomeros brazo largo**

136001	1/2 hp. monofásica eje largo HD
136002	1/2 hp. trifásica eje largo HD
136003	3/4 hp. monofásica eje largo HD
136004	3/4 hp. trifásica eje largo HD
136005	1 hp monofásica eje largo HD
136006	1 hp trifásica eje largo HD



**ANTICORROSIVO (LUBRICANTE)**

138004	Aerosol PNT 250 gr. (tipo WD40)
138005	Aerosol PNT 440 gr. (tipo WD40)



**ANTIPARRAS**

140001	Antiparra visor natural
140002	Antiparra respirador tipo trompa
140003	Repuesto filtro antigas/pintura



**AROS PARA LLANTAS**

148001	Aros p/llantas camión 750 x16
148002	Aros p/llantas camión 900 x 20



**AROS O'RING**

149001	Aros o'rings 17,5c. diámetro/llanta sin camara
149002	Aros o'rings 19,5c. diámetro/llanta sin camara
149041	Aros o'rings 22,5c. diámetro/llanta sin camara



**ASPIRADORA**

153001	Aspiradora manual polvo
--------	-------------------------



**BAJA TALONES**

157003	Baja talón super económico
157006	Baja talón llanta deportivo + alto que baja talón económico
157008	Baja talón tractor/camión (destalonadora)

**REPUESTOS**

157021	Juego guarnición baja talón tractor
157024	Resorte exterior b/talón
157025	Sopapa tipo aro b/talón
157028	Uña para baja talón
157030	Juego resorte super económico c/uno



**BALANCEADORAS**

159006	<b>BALANCEADORA CORGIAN IMPORTADA DU 1691</b>
159010	<b>BALANCEADORA SAN DIEGO COCHE/PICKUP DM 40</b>
159011	<b>BALANCEADORA SAN DIEGO CAMION DM 55</b>

**DATOS TÉCNICOS**

Peso max. de la rueda	65 Kg
Poder de consumo	200/370 W
Poder de abastecimiento para única fase	110/220V, 50/60Hz
Exactitud de balanceo	1g
Velocidad de balanceo	aproxim. 200 r.p.m
Diámetro de la llanta	10" a 22"
Tiempo	10 segundos
Peso neto	123 Kg
Nivel de ruido	<70dB
Límites de temperatura de funcionamiento	0 - 50 °C



159006

159010/11

3

**CODIGO**

**DESCRIPCION**

**BANCO PARA DESARME DE MOTOR**

161001	Banco de motor auto/pickup
161002	Banco de motor universal camión

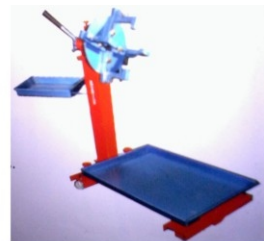

**BATEAS**

162001	Batea control pinchadura hasta 650 FIBRA REFORZADA
162002	Lava piezas bomba sumergible c/lámpara PALADINO



**CAMILLA**

162030	Camilla mecánica chapa reforzada 4 ruedas PALADINO
--------	----------------------------------------------------



**CAMARAS COCHE - PICKUP - CAMION**

163002	FR-13	163012	750 X 16 TR 150 A
163003	GR-13	163013	750 X 16 TR 75 A
163004	GR-14	163014	900 X 20 TR 75 A
163005	FR-15	163015	1000 X 20 TR 78 A
163006	GR-15	163016	1100 X 20 TR 78 A
163007	MR-15	163017	1100 X 22 TR 78 A
163008	GR-16	163018	1200 X 20 TR 78 A
163009	KR-16	163019	1200 X 24 TR 78 A
163010	KR-15	163025	11-22,5 TR 300 sin cámara
163011	750 X 16 TR 15	163026	12-22,5 TR 300 sin cámara
		163027	13-22,5 TR 300 sin cámara



**CAMARAS PARA CICLOMOTOR**

168202	300/350 x 8	168221	350 x 18
168204	400/450 x 8	168222	90/90 x 18
168206	300/350 x 10	168223	225 x 19
168210	275 x 14	168224	350 x 19
168211	275 x 17	168225	80/90 x 21
168212	300 x 17	168226	450 x 13
168213	300 x 18	168227	300/325 x 14
168217	225/250 x 16	168228	400/500 x 14
168218	225/250 x 17	168229	410/460 x 18
168219	300/325 x 16	168230	130/90 x 15
168220	250/275 x 18	168231	80/90 x 19



**CAÑOS PARA COMPRESOR - DE GOMA PVC - ESPIRALADO Y VAPOR**

180001	DUNLOP 300 libras 6mm.
180002	DUNLOP 300 libras 8mm.
180003	DUNLOP 300 libras 10mm.
180004	DUNLOP 300 libras 13mm.
180005	PVC 300 libras 6mm. tipo SOLIUM
<b>180020</b>	<b>Manguera CONTINENTAL 20 BAR 6mm.</b>
<b>180021</b>	<b>Manguera CONTINENTAL 20 BAR 8mm.</b>
<b>180022</b>	<b>Manguera CONTINENTAL 20 BAR 10mm.</b>
<b>180023</b>	<b>Manguera CONTINENTAL 20 BAR 13mm.</b>
<b>180029</b>	<b>Espiralado 5/16 GRILL-FLEX 6mm.</b>
<b>180030</b>	<b>Espiralado 3/8 GRILL-FLEX 8mm.</b>
<b>180031</b>	<b>Espiralado 1/2 GRILL-FLEX 10mm.</b>
<b>180040</b>	<b>CUTTER para cortar goma y espiralado</b>



**GOOD YEAR**



**CUTTER corta caño espiralado goma**



**CODIGO**

**DESCRIPCION**

**CARGADOR DE BATERIA**

193001 N° 0041 - 30 amp. carga arrancador 400 amp. 12 volt. portatil  
 193003 N° 0036 - 100 amp. carga arrancador 400 amp. 6/12 volt. carrito



**CARRETELES RETRACTILES**

195001 Para aire con manguera 1/4 8 mts.  
 195004 Para aceite (manguera 3/8 5 mts.) sin manguera



**CEPILLOS**

196001 Cepillo madera sin mango 6 x 19  
 196002 Cepillo madera con mango 4 x 19  
 196006 Cepillo centro aluminio 4 x 1 ROSTER  
 196007 Cepillo centro aluminio 6 x 1 ROSTER  
 196008 Cepillo centro chapa 4 x 1 ROSTER  
 196009 Cepillo centro chapa 5 x 1 ROSTER  
 196010 Cepillo mini para pulidora ROSTER



**CEPILLOS LAVADERO**

200001 Violín molipita 134 CERCRIM  
 200002 Violín pita mexicana 135 CERCRIM  
 200003 Camión pita 137 CERCRIM  
 200005 Tipo bote colectivo 238 CERCRIM



**COMPUESTOS**

201001 Rápido camara el kg. SEVICREM  
 201002 Rapido camara TG el kg.  
 201005 Compuesto negro x 2 kg. TG  
 201006 Cojín negro 2 kg. TG

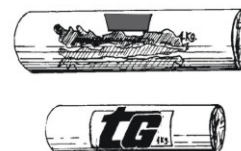

**CUCHILLOS**

202001 Cuchillo 10" ARBOLITO mango plástico  
 202002 Cuchillo 12" ARBOLITO mango plástico  
 202010 Cuchillo 10" ESKILTUNA mango plástico  
 202011 Cuchillo 11" ESKILTUNA mango plástico  
 202012 Cuchillo 12" ESKILTUNA mango plástico



**COMPRESORES CON MOTOR**

**NUEVO**

CODIGO	HP	TANQUE LITROS	MODELO	CAUDAL LITROS	PRESION LIBRAS	CILINDRO	MONOFASICO VENTA	TRIFASICO VENTA
208030	1	100	B/B	120	100	1		
208031	1	100	B/B	120	100	1		
208032	1 1/2	135	B/B	180	120	2		
208033	1 1/2	135	B/B	180	120	2		
208034	2	160	A/B	220	180	3		
208035	2	160	A/B	220	180	3		
208036	3	180	A/B	300	180	3		
208037	5 1/2	300	A/B	450	180	3		
208038	7 1/2	350	A/B	650	180	4	CON CONTACTOR	
208039	10 1/2	350	A/B	900	180	4	CON CONTACTOR	
<b>208040</b>	<b>5,5</b>	<b>100</b>	<b>A/Explosión</b>	<b>329</b>	<b>125</b>	<b>2V ESPECIAL ZONA RURALES</b>		
<b>WB-55100P</b>			<b>Mando a correa 2 cilindros en V.</b>			<b>NAFTERO PORTATIL</b>		

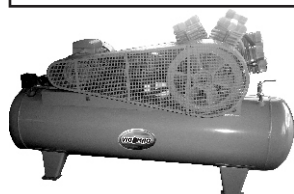

**CON PROTECTOR  
CONTRA ACCIDENTES**

**CON CUBRE POLEA  
CON MOTOR  
SIEMENS-CZERWENY  
BLINDADO  
GARANTIA 1 AÑO**

**TANQUES: PEDIR  
COTIZACION**



COD. 208040

**REPUESTOS COMPRESORES**

208041	Cabezal 2 hp. alta/baja 3 cilindros
208042	Cabezal 3 hp. alta/baja 3 cilindros
208043	Cabezal 5 1/2 hp. alta/baja 3 cilindros
208044	Canilla 1/4 esférica 2 hp.
208045	Canilla 3/8 esférica 3 hp.
208046	Canilla 1/2 esférica 5 hp.
208047	Canilla 3/4 esférica de 5 hp. y 7,5 hp.
208048	Robinete p/compresor rosca 1/4
208061	Válvula de retención 3/8 x 3/8 corta
208062	Válvula de retención 1/2 x 3/8 corta
208063	Válvula de retención 1/2 x 1/2 corta
208064	Válvula de retención 1/2 x 3/4 larga
208065	Válvula de retención 3/4 x 1" larga
208066	Válvula de seguridad 1/4 con tirador
208067	Válvula de seguridad 3/8 con tirador
208068	Válvula de seguridad 1/2 con tirador
208069	Válvula de despurque 1/4
208070	Válvula de despurque 3/8
208071	Válvula de despurque 1/2
208080	Canilla 1/4 de bronce 2 hp.
208081	Canilla 3/8 de bronce 3 hp.
208082	Canilla 1/2 de bronce 5 hp.
208083	Canilla 3/4 de bronce 5 hp / 7,5 hp.

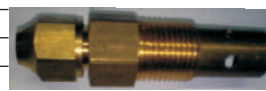

RETENCION



SEGURIDAD

DESPURGUE

**BAJA TALON DE TRACTOR CAMION**

**COMPRESOR 5HP**



CODIGO: 208037



CODIGO: 157008



CODIGO: 279004



# CONTRAPESOS MARCA:

# SOLMI

CODIGO MOD. GRS.	CODIGO MOD. GRS.	CODIGO MOD. GRS.
226000 N.1 5	226038 N.6 25	226085 N.18 10
226001 N.1 10	226039 N.6 30	226086 N.18 15
226002 N.1 15	226040 N.6 35	226087 N.18 20
226003 N.1 20	226041 N.6 40	226088 N.18 25
226004 N.1 25	226042 N.6 45	226089 N.18 30
226005 N.1 30	226043 N.6 50	226090 N.18 35
226006 N.1 35	226044 N.6 60	226091 N.18 40
226007 N.1 40	226045 N.7 10	226092 N.18 45
226008 N.1 45	226046 N.7 15	226093 N.18 50
226009 N.1 50	226047 N.7 20	226094 N.18 60
226010 N.1 60	226048 N.7 25	226095 N.19 75
226011 N.1 70	226050 N.7 30	226096 N.19 113
226012 N.1 80	226051 N.7 35	226097 N.19 170
226017 N.3 10	226052 N.7 40	226098 N.19 227
226018 N.3 15	226053 N.7 45	226099 N.19 283
226019 N.3 20	226054 N.7 50	226110 N.21 10
226020 N.3 25	226055 N.9 40	226111 N.21 15
226021 N.3 30	226056 N.9 60	226112 N.21 20
226022 N.3 35	226057 N.9 80	226113 N.21 25
226023 N.3 40	226058 N.9 100	226114 N.21 30
226024 N.3 45	226059 N.9 120	226115 N.21 35
226025 N.3 50	226060 N.9 140	226116 N.21 40
226200 N.4 10	<b>226061 ADHESIVO N.10</b>	226117 N.21 45
226201 N.4 15	<b>camión 6 oz.</b>	226118 N.21 50
226202 N.4 20	<b>226062 ADHESIVO N.11 banda</b>	226119 N.21 60
226203 N.4 25	<b>verde reforzado 60 grs.</b>	226120 N.28 5
226204 N.4 30	<b>226064 ADHESIVO N.11</b>	226121 N.28 10
226205 N.4 35	<b>banda roja 60 grs.</b>	226122 N.28 15
226206 N.4 40	226071 N.13 113	226123 N.28 20
226207 N.4 45	226072 N.13 170	226124 N.28 25
226208 N.4 50	226073 N.13 227	226125 N.28 30
226209 N.4 60	226074 N.13 283	226126 N.28 35
226026 N.5 10	226075 N.13 340	226127 N.28 40
226027 N.5 15	226076 N.13 395	226128 N.28 45
226028 N.5 20	226077 N.13 452	226129 N.28 50
226029 N.5 25	226078 N.14 113	
226030 N.5 30	226079 N.14 170	
226031 N.5 35	226080 N.14 227	
226032 N.5 40	226081 N.14 283	
226033 N.5 45	226082 N.14 340	
226034 N.5 50	226083 N.14 395	
226035S N.6 5	226084 N.14 452	
226036 N.6 15		
226037 N.6 20		



226151 auto adhesivo de 50 grs.  
20 unidades cinta amarilla de hierro

**CODIGO**

**DESCRIPCION**

**CRIQUE CAJA DIFERENCIAL CARRO**

228001	Sacar y colocar caja veloc. 1500 kg. camión tipo carro
228002	Hidráulico caja y diferencial / fosa 750 kg. para auto
228003	Hidráulico caja y diferencial / fosa 1500 kg. para camión



**CRIQUE BOTELLA HIDRAULICO**

230002	Botella reforzado base hierro fijo 15 tons. MS
230003	Botella reforzado base hierro tope fijo 20 tons. MS
230004	Botella reforzado base hierro tope fijo 30 tns, MS
230006	Botella base planchuela tope fijo 15 tns. OA
230007	Botella base planchuela tope fijo 25 tons,. OA
230008	Botella base planchuela tope fijo 35 tns. OA



**CRIQUE BOTELLA CON TORNILLO**

230015	Botella 15 tons. con tornillo fundición OA
230016	Botella 25 tons. con tornillo fundición OA
230017	Botella 35 tons. con tornillo fundición OA



**CRIQUE BOTELLA TELESCOPICO**

230020	Botella de 12 con tope OA
--------	---------------------------



**CRIQUE BOTELLA HIDRONEUMATICO**

230025	Botella hidroneumático 20 tons. (altura 300) MS
230026	Botella hidroneumático 20 tons. (altura 235) MS
230027	Botella hidroneumático 30 tons. (altura 300) MS
230028	Botella hidroneumático 20 tons. (altura 235) MS

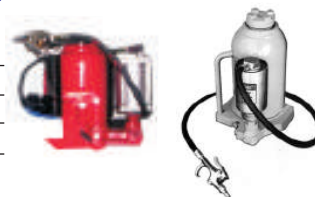

**CRIQUE BOTELLA HIDRONEUMATICO para colectivo**

230029	Botella hidroneumático 30 tons. altura 180 mm. MS (bomba de costado)
--------	----------------------------------------------------------------------



**CRIQUE BOTELLA CARRO HIDRONEUMATICO**

230030	Botella hidroneumático carro 20 tons. MS (peso 25 kg.)
230031	Botella hidroneumático carro 30 tons. MS (peso 35 kg.)



**CRIQUE CARRO HIDRAULICO**

230035	Carro corto común 2 tons. ERREBE
230036	Carro corto extra chato 2 tons. ERREBE
230037	Carro corto común 2 tons. SAVICREM
230038	Carro corto extra chato 2 tons. SAVICREM
230039	Carro largo 3 tons. RUA
230040	Carro largo 5 tons. RUA
230041	Carro largo chato 10 tons. RUA
230042	Carro corto IMPORTADO 21/4 / 3 tons, reforzado C.C.3
230043	Carro corto IMPORTADO 3 tons. chato C.C.3



**CRIQUE PORTATIL**

230045	RUA Portatil de 2 tns.
230046	Carro Corto Portatil 2 tns. 530 mm. largo IMPORT. C.C.2



**CODIGO**
**DESCRIPCION**
**REPUESTOS CRIQUE CARRO: plato/ruedas y guarnición**

230047	Rueda plástica delantera común 2 tns. ERREBE
230048	Rueda plástica delantera extra chato 2 tns. ERREBE
230049	Rueda plástica trasera común/extra chato 2 tns. ERREBE
234050	Plato de apoyo carro largo 2 y 3 tns.
234051	Plato de apoyo carro largo 5 tns.
<b>RUEDAS GRANDES DELANTERAS CRIQUE CARRO</b>	
230055	Portatil 2 tns. diámetro 63 ancho 25 agujero 12
230056	Carro largo 2/3 tns. diamet.113 ancho 42 agujero 20
<b>RUEDAS CHICAS TRASERAS SIN HORQUILLA</b>	
230057	Portatil 2 tns. diámetro 40 ancho 18 agujero 10 Grilón
230058	Portatil 6 tns. diámetro 63 ancho 25 agujero 11 Fundición
230059	Carro corto 2/3 tns. diámetro 63 ancho 25 agujero 11 Fundición
<b>HORQUILLA SOLA SIN RUEDA</b>	
230060	Carro corto 2 y 3 tns.
230061	Carro largo 2 y 5 tns.

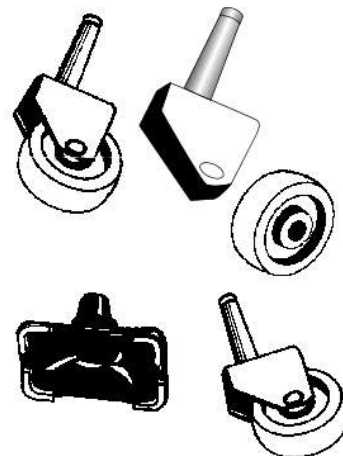
**DESARMADORAS**

264001	Desarmadora CORGIAN importada neumática de coche DU1003
264003	Desarmadora CORGIAN importada neumática de camión
264004	RUN FLAT - PAX SYSTEM "PURVIS"
264005	Desarmadora PURVIS neumática de coche monofásica
264006	Desarmadora PURVIS neumática de coche trifásica
264010	Desarmadora de camión neumática <i>Gubi</i>
<b>REPUESTOS PURVIS</b>	
264020	Uña p/desarmadora
264021	Uña desarmadora tipo importada
264022	Uña desarme moto cada una
264023	LLave inversora
264024	Inversora de válvula 5 vías con tapa
264025	Válvula aire 3 vías baja talón
264026	Válvula 5 vías mordaza
264027	Resorte cónico baja talón
264028	O'rings eje cilindro
264029	Derivador - distribuidor
264030	Eje hexagonal c/uña completo
264031	O'ring para válvula 3 vías baja talón
264032	Pistón cilindro chico
264033	Resorte brazo
264034	O'ring p/válvula 5 vías el juego
264035	O'ring baja talón (modelo nuevo) sopapa
264040	Protector plástico uña de desarmadora importada
264045	Taco de goma chico
264050	Taco goma grande nuevo modelo

**Nueva Pedalera Automática**

• Plato autocentrante potenciado de cuatro mordazas para operar con ruedas de:

10 a 21" con bloqueo desde el interno

10 a 16" con bloqueo desde el externo

DATOS TECNICOS: COD. 264005/06

-Bloqueo autocentrante desde el interno: 13 - 21"

-Bloqueo autocentrante desde el externo 10 - 18"

-Apertura desmonta talón: 320 mm. (13")

-Presión del ejercicio: 10 bar (145 PSI)

-Motor monofásico/trifásico: 1 HP

-Altura máxima: 1700 mm.

-Ancho máximo: 500 mm.

-Profundidad máxima: 1000 mm.

-Peso aproximado: 170 kg.



Fuerte plato rotativo y ajustable para todo tipo de llantas.  
Columna trasera ajustable, operada por aire.  
Un eje con traba de seguridad y brazo horizontal al mismo tiempo.  
El dispositivo del GH de palanca levantadora y de presión, hará la tarea con menor demanda física



Cod. 264004

**Nota:**

Este accesorio es adaptable a cualquier Tipo y Marca de desmontadora de cubiertas, cuya instalación es de fácil montaje.

**RUN FLAT - PAX SYSTEM**

264020

# DESMONTA NEUMATICOS UNIVERSAL PARA RUEDAS DE 15" - 25"

Arma y desarma cubiertas sin cámara

*"Gubi"*



CODIGO: 264010

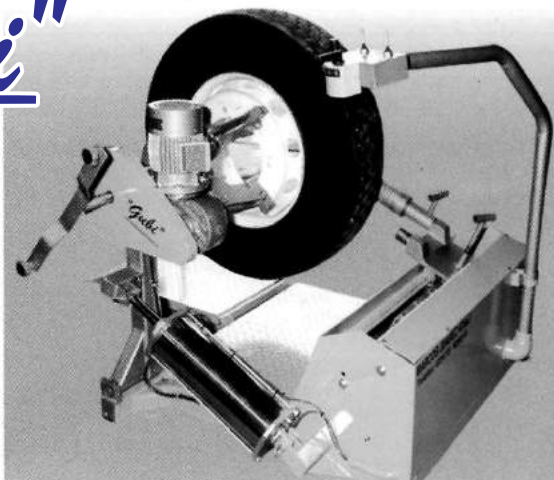

## DATOS TECNICOS

Ancho: 1550 mm.

Largo: 2250 mm. (c/rampa)

1250 mm. (s/rampa)

Peso: 560 Kg.

Motor: 3 fases 1,50 hp 380 v.

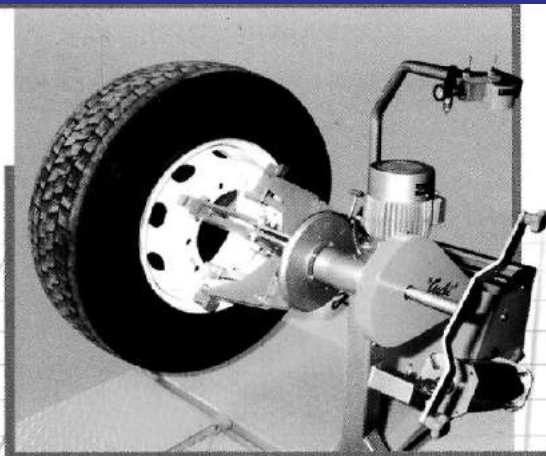

Desentalona todo tipo de cubiertas con aro

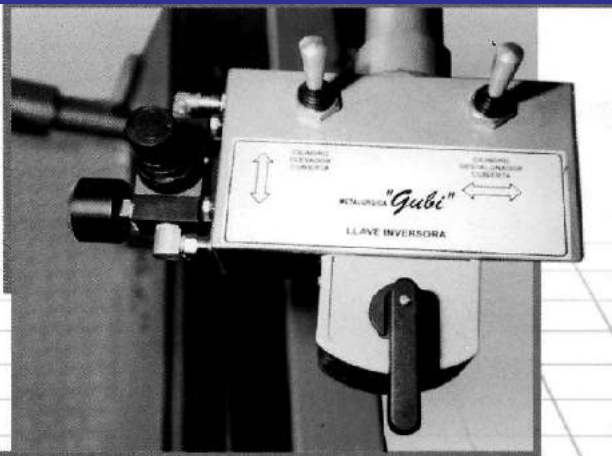

Comandos electro-neumáticos

## DESMOLDANTES

277001	Silicona envase 1 Lt.. SAVICREM
277002	Silicona envase 5 Lts. SAVICREM



## DISYUNTORES REPUESTOS

277030	Modelo C- 1,5 HP. monofásico CER
277031	Modelo O-T 2 HP. monofásico y 3 HP trifás. CER
277032	Modelo O- 3 HP. monofásico CER
277033	Modelo 1L - 5,5 HP. trifásico CER
277034	Modelo 1 7,5 HP. trifásico CER
277037	Válvula de seguridad
277038	Diafragma chico/mediano/grande

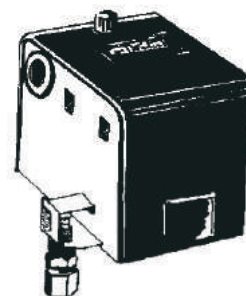

**CODIGO**
**DESCRIPCION**
**EXPANSOR HIDRAULICO**

278001	Expansor 12 tns. 40 piezas en cofre
278004	Expansor p/colectivo cofre 18 piezas 20 tns.

**ELEVADORES**

279001	4 colum. auto/pickup 4500 kg. ET 445M TELME
279003	2 col. auto pick up 3000 kg. trifásica EAH-3000-T
279004	Elevador plataforma para moto grande

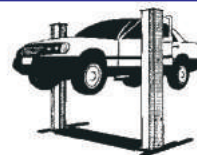
**ENGRASADORAS**

280001	Engrasadora 1 kg. a/palanca
280002	Engrasadora 3 kg. a palanca
280003	Engrasadora 5 kg. a palanca
280004	Engrasadora 10 kg. a /palanca
280006	Bomba de trasbase p/sacar aceite a palanca
280007	25kg. equipo neumático
280008	Pistola p/engras. neumática GROZ importada
280010	Repuesto pistola «Z»
280011	Embudo con pedestal 20 lts.
280013	Jeringa p/sacar aceite diferencial 1 kilo
280016	Bomba neumática p/tambor 200 kg. grasa
280017	Bomba neumática p/tambor 200 L. aceite

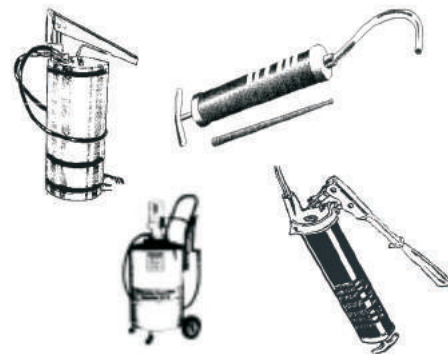
**FILTROS**

289001	Lubricador 1/4 completo (ACEITE SAE 10)
289002	Lubricador 1/2 completo (ACEITE SAE 10)
289003	Filtro mini para desarmadoras
289008	Filtro SILENCIADOR p/compresores 2 a 4 hp.
289010	Filtro SILENCIADOR p/compresores 5 a 12 hp.

**REPUESTOS DE FILTROS**

289013	Regulador y filtro 1/4 agua
289014	Regulador y filtro 1/2 agua
289015	Lubricador 1/4 aceite
289016	Lubricador 1/2 aceite
289017	Vaso filtro 1/4 agua
289018	Vaso filtro 1/2 agua
289019	Vaso lubricador 1/4 aceite
289020	Vaso lubricador 1/2 aceite
289021	Juego guarnición regufiltro 1/4
289022	Juego guarnición regufiltro 1/2
289023	Visor lubricador 1/4
289024	Visor lubricador 1/2
289027	Filtro 1/4 (trampa de agua)
289028	Filtro 1/2 (trampa de agua)

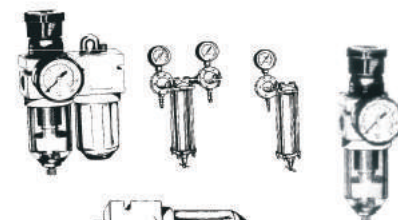

**EL COMPRESOR LO ENLACE  
CON EL RUIDO ?**

**FILTRO "SILENCIADOR"  
para COMPRESORES**

Cod. 289008 Cod. 289010 Cod. 289011

**FLUX**

293001	Flux 1 litro SAVICREM
293002	Flux 5 litros SAVICREM
293003	Flux 20 litros SAVICREM
293004	Flux 1 litro TG
293005	Flux 5 litros TG
293006	Flux 20 litros TG

**FRANELA**

296002	Franela gamuzada 40x50
--------	------------------------

**GOMITAS**

299001	Gomitas raccord /corto x 10 unidades
299002	Gomitas raccord /dual x 10 unidades
299003	Gomitas para acople por unidad



**CODIGO**

**DESCRIPCION**

**GRABADORAS**

303002	Grabadora coche mango/plastico
303005	Grabadora de cubierta eléctrica BOXCEL Ind. Arg. tipo Rillfit
303016	Cuchilla grabadora común la unidad N° 1, 2, 3 y 4
303022	Porta cuchilla Rillfit Germany
303023	Cuchilla tipo Rillfit x 20 unidades
303024	Cuchilla tipo Rillfit x 10 unidades
<b>REPUESTOS</b>	
303017	Cabezal p/grabadora (303002)
303019	Caños p/grabadora (303002)
303020	Mango plástico p/grabadora (303002)



**GRABADORA DE CUBIERTA ELECTRICA BOXCEL - INDUSTRIA ARGENTINA TIPO RILLFIT**

**GARANTIA 6 MESES**



303005

**GUANTES**

307001	Guantes pistola puño corto reforzado
307005	Guantes hilo con PVC s/palma mano doble hilado reforzado
307006	Guantes TERRY CLOTH
307007	Guantes vaqueta amarillo 1/2 paseo



**GUINCHES**

311002	Guinche Pluma 700 kg. HD
311003	Guinche Pluma 1200 Kg. HD



**HIDROLAVADORAS**

313001	Agua fria motor 5.5 HP 15 lts. x m 150 bar 150 completa
313003	Agua caliente/fria motor 7.5 HP 15 lts. x m 200 bar MAX200 completa



**INTERIORES**

314003	Interior b./metal importado de coche	<b>Negro</b>
314004	Interior b./metal importado de coche	<b>Rojo</b>
314005	Para válvula vial importado	



**INFLADORES**

318001	Inflador c/pulmón auto y bicicleta
318002	Inflador c/pulmón y manómetro auto/bici
318003	Cuero de inflador



**LEZNA Y LIMA**

326001	Lima cola de ratón
326003	Lezna saca clavos



**LIMPIA MANOS**

329001	Limpia manos sin agua 600 grs. (GEL) PNT
329002	Limpia manos sin agua 1,200 kg. (GEL) PNT
329003	Limpia manos sin agua, Balde por 4 kg. (GEL) PNT



**LLAVES CRIQUE**

330001	Llave crique 1/2 trabajo pesado
330002	Llave crique 1/2 AIRMAX importado AT5053



**CODIGO**
**DESCRIPCION**
**LLAVES CRUZ**

331002	3 Y 4 bocas gomero MASTER IOMA
<b>331003</b>	<b>3 bocas deportiva IOMA</b>
331004	3 bocas económica ROJA IOMA pulgada
331005	3 bocas económica VERDE IOMA milimétrica
331006	4 bocas japonesa IOMA
331007	3 y 4 bocas gomero RASELLI
331008	4 bocas japonesa RASELLI
331009	3 bocas y 1 cuadrado de 1/2 RASELLI

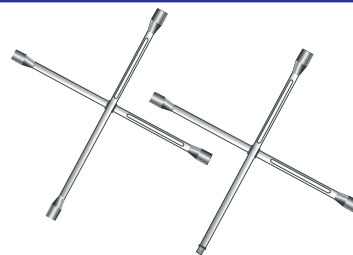
**LLAVES TUBO**

335002	Llave tubo de camión RASELLI 19 x 24 mm.
335003	Llave tubo de camión RASELLI según detalle de medidas
335004	Llave tubo de camión RASELLI 21 x 41 mm.
335005	Llave tubo de camión IOMA Ford 1 1/2 x 13/16
335006	Llave tubo de camión IOMA Toyota 1 5/8 x 13/16
335007	Llave tubo de camión IOMA según detalle de medidas

**LLAVE AFLOJA TUERCA CAMION - VIAL**

335020	Llave afloja tuerca CAMION 1.68
335021	Llave afloja tuerca VIAL

**LLAVES TUBO PARA CAMION**

MODELO Nº	MEDIA BOCA Milímetros-pulgadas		CORRESPONDE A CAMION MODELO
<b>1</b>	19	3/4	MERCEDES BENZ 608 - TATA BORGWARD
	24	15/16	
<b>2</b>	22	7/8	CHEVROLET 1938 - 1940 BORGWARD
	24	15/16	
<b>3</b>	24	15/16	BORGWARD GROOSPAL - DODGE 700 - MERCEDES BENZ hasta 1986 - MAGIRUS DEUTZ
	27	1 1/16	
<b>4</b>	30	1 3/16	MERCEDES BENZ desde 1986 hasta 1995 - SCANIA - VOLVO DE CAROLI hasta 1995 - FORD 350 - DODGE 700 - IVECO hasta 1995 BEDFORD - LEYLAN - SCANIA VABIS - AUSTIN - FORD CARGO 1730 (TODOS)
	33	1 5/16	
<b>5</b>	27	1 1/16	GROOSPAL - DODGE 700 - MERCEDES BENZ hasta 1986 MAGIRUS DEUTZ MERCEDES BENZ desde 1986 hasta 1995 - SCANIA - VOLVO DE CAROLI hasta 1995 - FORD 350 - DODGE 700 - IVECO hasta 1995
	30	1 3/16	
<b>6</b>	27	1 1/16	GROOSPAL - DODGE 700 - MERCEDES BENZ hasta 1986 - MAGIRUS DEUTZ UNIMOG - ACOPLADOS - MERCEDES BENZ hasta 1996 IVECO hasta 1996 - SCANIA VABIS - DE CAROLI hasta 1996
	32	1 1/4	
<b>7</b>	27	1 1/16	GROOSPAL - DODGE 700 - MERCEDES BENZ hasta 1986 - MAGIRUS DEUTZ - FORD CARGO 1730 (TODOS) BEDFORD - LEYLAND - SCANIA VABIS - AUSTIN
	33.3	1 5/16	
<b>8</b>	21	13/16	☐ CAPUCHON DE CAROLI desde 1996 - FORD - CHEVROLET - DODGE 700 - FARGO - DESOTO
	38	1 1/2	
<b>9</b>	32	1 1/4	UNIMOG - ACOPLADOS - SCANIA VABIS - MERCEDES BENZ hasta 1996 - IVECO desde 1996 - DE CAROLI desde 1996 BEDFORD - LEYLAN - SCANIA VABIS - AUSTIN - FORD CARGO 1730 (TODOS)
	33.3	1 5/16	
<b>10</b>	30	1 3/16	MERCEDES BENZ desde 1986 hasta 1995 - SCANIA - VOLVO DE CAROLI hasta 1995 - FORD 350 - DODGE 700 - IVECO hasta 1995 UNIMOG - ACOPLADOS - SCANIA VABIS - MERCEDES BENZ desde 1996 IVECO desde 1996 - DE CAROLI desde 1996
	32	1 1/4	
<b>11</b>	21	13/16	☐ CAPUCHON CAMION TOYOTA - KAMAZ
	41	1 5/8	
<b>12</b>	32	1 1/4	UNIMOG - ACOPLADOS - SCANIA VABIS - MERCEDES BENZ hasta 1996 IVECO desde 1996 DE CAROLI desde 1996 - FORD - CHEVROLET - DODGE 700 - FARGO - DESOTO
	38	1 1/2	

**MANDRILES**

339001	Mandril p/banco No.2
--------	----------------------

**MANGUERA ENGRASE ALTA PRESION**

342001	Manguera alta presión 0,30
342002	Manguera alta presión 0,50
342003	Manguera alta presión 1,20



**CODIGO**
**DESCRIPCION**
**MANGUERA ENGRASE MEDIA PRESION**

342006	Manguera p/balde engrase 30 cm.
342007	Manguera p/balde engrase 50 cm.
342008	Manguera p/balde engrase 1,20 cm.

**MANOMETRO PARA COMPRESOR**

346001	Para compresor 7 kg. 100 libras
346002	Para compresor 10 kg. 150 libras
346003	Para compresor 14 kg. 200 libras
346004	Para compresor 20 kg. 300 libras

**MARTILLOS**

349001	Martillo pena y goma
349020	Puños de goma
349021	Tacos de goma

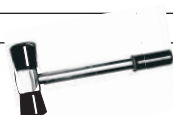
**MAZAS**

350001	Maza cabo corto/largo 2kg.
350003	Maza cabo corto/largo 3kg.
350005	Maza cabo corto/largo 4kg.
350007	Maza cabo corto/largo 5kg.
350020	Cabo corto madera 50 cms.
350021	Cabo largo madera 60 cms.

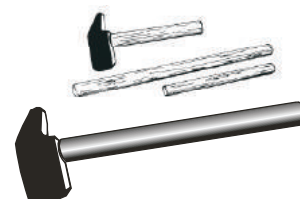
**MORZAS**

351001	Morza Nº 1
351002	Morza Nº 2
351003	Morza Nº 3
351004	Morza Nº 4
351005	Morza Nº 5
351006	Morza Nº 6

**SOMOS DISTRIBUIDORES**

**MOTORES ABIERTOS MONOFASICOS 1500 RPM**

352001	Motor 1 HP
352002	Motor 1 ½ HP
352003	Motor 2 HP
352004	Motor 3 HP Blindado

**LOS MEJORES MOTORES DEL MUNDO**

**MOTORES BLINDADOS TRIFASICOS 1500 RPM**

352010	Motor 1 HP
352011	Motor 1 ½ HP
352012	Motor 2 HP
352013	Motor 3 HP
352014	Motor 5 HP
352015	Motor 7 ½ HP

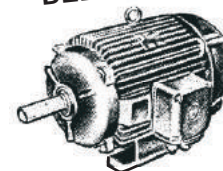
**LOS MEJORES MOTORES DEL MUNDO**

**MEDIDORES DE COMODIN Y VARIOS**

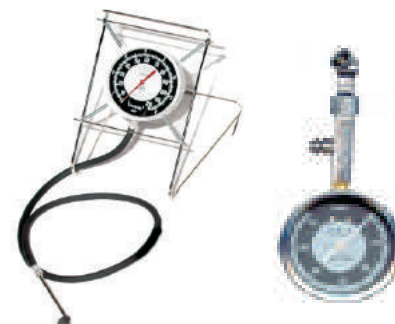
359002	Medidor comodin 120/200L. CIMPA
359004	Med.comodin 120L./200L. CIMPA c/protector
359009	Bolsillo 50Lbs.raccord/corto CIMPA
359010	Bolsillo 150Lbs.raccord/corto CIMPA
359011	Bolsillo 100 libras raccord dual CIMPA
359012	Bolsillo 150 libras raccord dual CIMPA
359015	Medidor tractor No.9350S importado
359017	Medidor camión DUNLOP SUPER LARGO
359018	Reloj 1 faz 120/200 especial p/ Gomerías y Estación de Servicio CAJA DE CHAPA - CIMPA
359019	Reloj 1 faz electrónico 35 cms. DP 100





**CODIGO**
**DESCRIPCION**
**MEDIDORES DE COMODIN Y VARIOS**

359021	Poste Gabinete elect.dig.aut.MP300 PF "YPF"
359022	Gabinete calibrador MP 100
359023	Infla mide 60 / 180 libras especial Gomería
359024	Gabinete electrónico poste MP300 PA agua/aire
359025	Medidor infla-mide digital 150 libras Profesional
359026	Manual p/profundidad cubierta
359027	Gabinete infla y mide Mp200
359028	Infla y mide con manómetro 150 libras
359029	Infla y mide PROFESIONAL tipo Michelin WONDER SUPERDAINU
359033	Manguera p/reloj comodín
359034	Vidrio para comodín
359037	Protector de goma con aro hierro para comodín
359039	Recambio comodín CIMPA común



•COMODINES "RECAMBIO": Se enviarán solo cuando tengamos el medidor a cambiar en nuestro poder

**NUMERADOR**

360001	Numerador eléctrico p/cubierta (cabezal completo)
360002	Resistencia (cabezal completo) (para 360001)
360003	Numerador eléctrico para cubiertas SAVICREM
360004	Resistencia PARA NUMERADOR SAVICREM (para 360003)
360005	Grabado logo p/numerador

**PALANCAS NACIONALES E IMPORTADAS**

376002	Juego palancas tipo TNT 200 Ind. Argentina
376003	Palanca tipo Raselli 2 uñas de 50 cms.
376004	Palanca tipo Raselli 2 uñas de 60 cms.
376005	Sacar cubierta 2 uñas 500mm. RASELLI
376006	Sacar cubierta 2 uñas 600mm RASELLI
376008	Palanca moto 2 uñas Raselli
376009	Sacar cubierta t/Michelin N°1 (70 cm.) SAVICREM
376010	Sacar cubierta t/Michelin N°2 (70 cm.) SAVICREM
376011	Sacar cubierta t/Michelin N°1 (1.20 mt.) SAVICREM
376012	Sacar cubierta t/Michelin N°2 (1.20 mt.) SAVICREM
376013	Palanca sacar cub.comun 1 uña SAVICREM
376014	Palanca sacar cub.reforzada 1 uñas SAVICREM
376016	Palanca s/cubierta reforzada 2 uñas SAVICREM
376018	Palanca de moto 2 uñas cincada SAVICREM
376020	Palanca pata de chancho reforzada SAVICREM
376022	Palanca saca aros SAVICREM
376023	Palanca tipo DUMLOP
376024	Barreta 1,20 mts. 2 puntas SAVICREM
376026	Barreta 1,20 mts. punta cuchara SAVICREM
376028	Barreta 1.60 mts. punta y cuchara SAVICREM

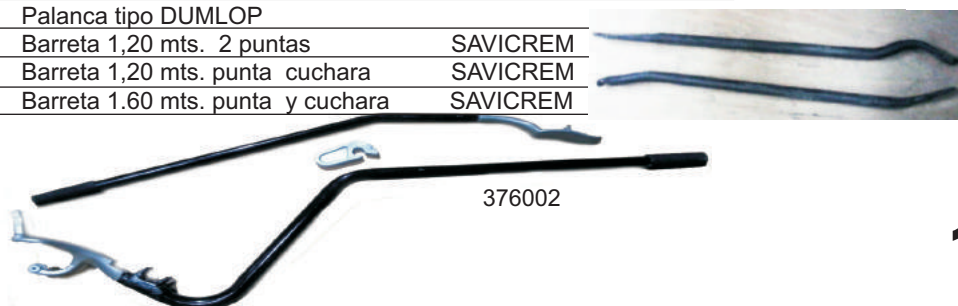

376002

**CODIGO**
**DESCRIPCION**
**PASANTE DE FUERZA**

379002	Pasante p/llave tubo RASELLI (60 cm.)
379005	Pasante p/llave tubo SAVICREM 60 cm.
379006	Pasante p/llave tubo IOMA 60 cm.

**PASTA LUBRICANTE**

380004	Vegetal pote x 1kg. TG
380005	Vegetal pote x 4 kg. TG
380006	Vegetal pote x 20 kg. TG
380007	Vegetal pote x 1kg. LUBRIGOM
380008	Vegetal pote x 4kg. LUBRIGOM
380009	Vegetal pote x 20kg. LUBRIGOM
<b>380010</b>	<b>Pasta lubricante p/arme y desarme SAVICREM X 1kg.</b>
<b>380011</b>	<b>Pasta lubricante p/arme y desarme SAVICREM X 4kg.</b>
<b>380012</b>	<b>Pasta lubricante p/arme y desarme SAVICREM X 10kg.</b>
<b>380013</b>	<b>Pasta lubricante p/arme y desarme SAVICREM X 20kg.</b>

**PICOS DESINFLA - INFLA CAMARA**

389002	Desinfla camara de bronce
389003	Desinfla camara hierro
389004	Pico inflador p/bicicleta/coche

**PICOS ENGRASE**

393001	Pico engrase chico
393002	Pico engrase grande
393003	Pico con asiento goma
393004	Pico punta recta flecha
393005	Pico punta curva flecha
393009	Aguja engrase
393012	Pico engrase chico de 4 uñas

**PIEDRAS**

396006	Chaira con mango
396007	Chaira 198 "GRIDEST"
396009	Piedra circular 4x1 GRIDEST-ATLANTA
396010	Piedra circular 5x1 GRIDEST-ATLANTA
396011	Piedra circular 6x1 GRIDEST-ATLANTA
396012	Punta montada A4 CARBORUNDUM
396013	Punta montada A5 CARBORUNDUM
396014	Punta montada A12 CARBORUNDUM
396015	Punta montada A36 CARBORUNDUM
396016	Punta montada W236 CARBORUNDUM
396017	Punta montada A21 CARBORUNDUM
396018	Punta montada A25 CARBORUNDUM
396019	Bujes para piedras

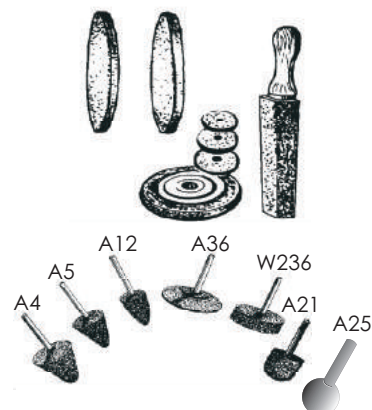
**PINCELES PARA FLUX**

399001	Pinceles para flux N° 3
399002	Pincel para flux N° 4



**CODIGO**

**DESCRIPCION**

**PINZAS DE CONTRAPESOS**

403001	Pinza p/contrapesos
403002	Pinza p/contrapesos "CORNETA" importada



**PISTOLAS DE DESEMPOLVAR Y OTRAS**

404001	P-1 Modelo desempolvadora pico corto
404002	P-2 Modelo desempolvadora pico de 150mm.
404005	P-AR-1 Modelo desempolvadora pico alto rendimiento super
404007	P-BICI-D Modelo para inflar bicicleta/auto pico doble
404010	PR-1 Modelo para aplicación de revestimiento anticorrosivo
404011	P-SIL Modelo para aplicación adhesivo de siliconas
404012	R-1 Modelo rociadora c/recipiente metálico 1 lt.
404013	P-A Modelo arenadora con manguera 2 m.
404014	P-Lav. modelo lavado sin válvula



404001



404002



404010



404012

**REPUESTOS**

404030	Repuesto pico corto desempolvadora P-1
404031	Repuesto pico 150mm. desempolvadora P-2
404032	Repuesto pico 300 mm. desempolvadora P-3
404038	Repuesto caño exterior rociadora R-1
404039	Repuesto pico exterior rociadora
404045	Repuesto pico p/inflar neumáticos/doble P-BICI-D



404007



404013



404014



404005



404011

**PISTOLAS DE IMPACTO NEUMATICAS**

405005	Impacto 1/2 imp. Económica AIRMAX AT5040
405008	Impacto 1/2 reforzada AIRMAX AT5044
405012	Impacto Chicago CP 7733 1/2" Pesada
405013	Impacto Zantic ZC733 1/2"
405014	Impacto I. Rand 231H 1/2" Pesada
405015	Impacto Zantic ZC720/6 1" doble martillo
405016	Impacto I. Rand 1" IR285B/6
405017	Impacto Chicago 1" CP97-6 Pesada
405022	Impacto Airmax 1" eje largo AT6081
405023	Zantic 3/4 ZC740 martillo simple
405024	Zantic 3/4 ZC740ES martillo doble
405026	Impacto 3/4 uso pesado AT 430 - 2
405040	Carrito transportador de pistola de 1"



**CODIGO**

**DESCRIPCION**

**PRECINTOS DE PLASTICO**

406001	Precinto 300 x 5 mm. paquete x 100 c/u color aluminio
406002	Precinto 400 x 5 mm. paquete x 100 c/u color aluminio



**PRENSAS DE PIE Y BANCO**

407001	Prensa banco 15 tns.2 columnas HD
407002	Prensa pie 15 tns.4 columnas HD
407003	Prensa pie 20 tns.4 columnas HD

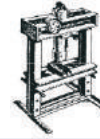

**PRENSA ESPIRALES NEUMÁTICA Y MANUAL**

407025	Prensa espiral neumática de banco
407026	Prensa espiral de banco manual

VER PIE DE PAGINA

**PRENSA ESPIRALES NEUMÁTICA Y MANUAL**



- *Precisión, seguridad y rapidez garantizada*

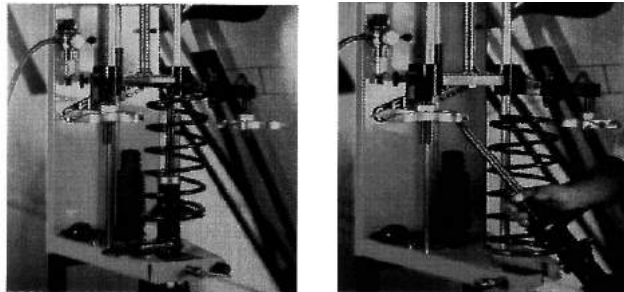

- *Permite el reemplazo de distintos componentes de la suspensión en solo 90 segundos*

- *Solo 80 Lbs. de presión*



CODIGO

DESCRIPCION

**PROTECTORES**

409011	Protector 750 x 16 COMPUESTO 1
409012	Protector 900/1000 x 20 (165 x 20) COMPUESTO 1
409013	Protector 1100/1200 x 20 (215 x 20) COMPUESTO 1
409014	Protector 1200 x 20 (más ancho) NUEVO COMPUESTO 1



**PULIDORAS**

411002	Pulidora con eje flexible caucho directo N° 1 (3/4 MONOFÁSICA)
411003	Pulidora con eje flexible caucho N° 3 (3/4 MONOFÁSICA)
<b>411004</b>	<b>Pulidora neumática c/boquilla imp. AIRMAX AT7033</b>
<b>411006</b>	<b>Pulidora neum. AIRMAX c/boquilla 10 puntas AT7033K</b>
411008	Pulidora I.Rand baja velocidad 3000 RPM imp.
411020	Eje flexible caucho para polea y directo
411022	Alma de flexible

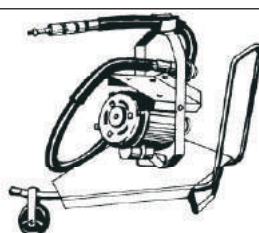

**RACCORDS**

413001	Raccords corto p/manguera 6mm. M-H
413002	Raccords corto p/acople 1/4 M-H
413003	Raccords corto p/manguera 8 mm. M-H
413016	Raccord dual 160 mm. M-H
413017	Raccord dual SUPER 200 mm. M-H
413018	Raccords dual de 160 mm. para acople M-H
413019	Raccords dual SUPER de 200 mm. para acople M-H
413020	Raccords dual para comodín o medidor M-H
413025	Raccords tipo MICHELIN sin retención para manguera M-H
413026	Raccords tipo MICHELIN con retención para manguera M-H
413027	Raccords tipo MICHELIN con retención rosca 1/8 hembra M-H
413030	Raccords tipo MICHELIN sin retención vial
413035	Hidroraccords
413036	Adaptador de hidroraccords
413037	Raccords tipo MICHELIN importado sin retención
413038	Raccords tipo MICHELIN importado con retención



**CODIGO**
**DESCRIPCION**
**RASPAS CIRCULARES**

416001	BCR No.5 el juego TIPO SOL
416002	BCR No.6 el juego TIPO SOL
<b>416005</b>	R5 - PINCOTT P5 Importada Australia 5 unidades
<b>416006</b>	R6 - PINCOTT P6 Importada Australia 6 unidades

**RASPAS CUCHILLAS**

417001	6x2 PC-85 SR pulido rápido
417002	6x2 PC-85 pulido normal
417003	6x2 NUCLEO
417004	9x3 PC-84 SR pulido rápido
417005	9x3 PC-84 pulido normal
417006	9x3 PC-88 SR pulido rápido
417007	9x3 PC-88 pulido normal
<b>417015</b>	Pincott ULTRA II juego x nucleo AUSTRALIA 28 unid. eje 6mm.
<b>417016</b>	Pincott ULTRA IIE juego x nucleo AUSTRALIA 28 unid. eje 8mm.
<b>417017</b>	Pincott R115-25 juego x nucleo AUSTRALIA 28 unid. eje 8mm.
<b>* 417018</b>	Pincott R4-25-S juego x nucleo AUSTRALIA 28 unid. eje 6mm.
<b>417019</b>	Pincott R4-20-U juego x nucleo AUSTRALIA 28 unid. eje 8mm.

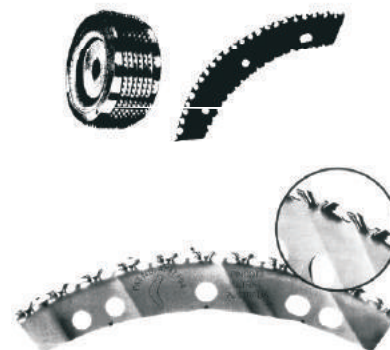

**\*Al colocar estas cuchillas en el núcleo, la marca va hacia arriba.**

**Estas cuchillas se usan en máquinas que la raspa gira en forma horizontal con relación a la cubierta.**

**RASPAS PLOMO**

417050	Raspas 3 x 1/2
417051	Raspa 3 x 1
417052	Raspa 3 x 2

**RASPAS TUNGSTENO ROCKET**

423001	Muela redonda 42-480 (2" x 5mm.) GF
423004	Muela redonda 42-481 (2" x 5mm.) GG
423007	Muela redonda 42-482 (2" x 10mm.) GF
423010	Muela redonda 42-485 (2" x 13mm.) GG
423013	Muela redonda 42-486 (2" x 19mm.) GF
423016	Muela redonda 42-483 (2" x 10mm.) GG
423019	Muela redonda 42-484 (2" x 13mm.) GF
423022	Muela redonda 42-699 (1 1/2 x 3mm.) GF

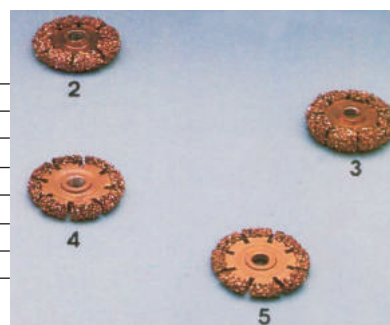

423025	Lápiz 42-220 (diam. 3mm.) GG
423028	Lápiz 42-221 (diam. 6mm.) GG
423031	Lápiz 42-222 (diam. 6mm.) GF
423033	Lápiz 42-725 (diam. 6mm.) GG
423036	Lápiz 42-726 (diam. 6mm.) GF



423039	Copa 42-185 (2" x 1") GG vent.
423042	Copa 42-186 (2" x 1") GF vent.

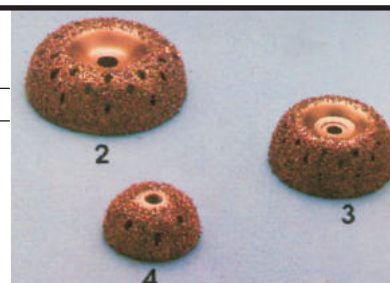

<b>423045</b>	<b>Plato 42-489 (2,5 x 16mm.) GF</b>
423060	Acople ejes para TUNGSTENO



**CODIGO**
**DESCRIPCION**
**RESISTENCIAS**

425002	Resistencia 1B. reforzada
425004	Resistencia 2B. reforzada
425006	Resistencia combi-coche reforzada
425008	Resistencia reforzada combi-camión
425010	Resistencia VULCANO redonda
425012	Resistencia grabadora SUPER REFORZADA

**RODILLOS**

<b>427001</b>	<b>Rodillo dentado SAVICREM</b>
427002	Rodillo plano

**SACA FILTRO**

428001	Saca filtro a cadena para coche <b>HELIOT</b>
428002	Saca filtro a cadena para camión <b>HELIOT</b>
428003	Saca filtro 66 mm. de diámetro zuncho ancho
428004	Saca filtro 77 mm. de diámetro zuncho ancho
428005	Saca filtro 85 mm. de diámetro zuncho ancho
428006	Saca filtro 93 mm. de diámetro zuncho ancho
428007	Saca filtro 108 mm. de diámetro zuncho ancho
428008	Saca filtro 137 mm. de diámetro zuncho ancho
428009	Saca filtro c/una mano <b>RUCCI</b>

**SEPARADORES**
**COCHE - CAMIONETA - DOBLE CABINA**

431101	Separador 7 mm. 4 agujeros
431102	Separador 10 mm. 4 agujeros
431103	Separador 15 mm. 4 agujeros
431104	Separador 20 mm. 4 agujeros
431105	Separador 25 mm. 4 agujeros
431115	Separador 7 mm. 5 agujeros
431116	Separador 10 mm. 5 agujeros
431117	Separador 15 mm. 5 agujeros
431118	Separador 20 mm. 5 agujeros
431119	Separador 25 mm. 5 agujeros
431120	Separador 30 mm. 5 agujeros

**PICK UP IKA**

431130	Separador 7 mm. 5 y 6 agujeros
431131	Separador 10 mm. 5 y 6 agujeros
431132	Separador 15 mm. 5 y 6 agujeros
431133	Separador 20 mm. 5 y 6 agujeros
431134	Separador 25 mm. 5 y 6 agujeros
431135	Separador 30 mm. 5 y 6 agujeros
431136	Separador 35 mm. 5 y 6 agujeros
431137	Separador 40 mm. 5 y 6 agujeros

**SOLDADORAS ELECTRICAS**

433002	SRM N° 12 - 190 amp. portatil
433003	SRM N° 003 - 220 amp. portatil
433004	SRM N° 014 - 235 amp. turbo / carrito
433005	SRM N° 008 - 255 amp. turbo / carrito
433006	N° 0006 200 amp. soldar y 30 amp. cargador <b>combinada</b>

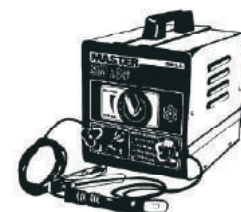

CODIGO

DESCRIPCION

**SOLDADORAS MIG - MAG**

433012	USO CHAPISTA TRIFASICA T 205
433013	USO CHAPISTA MONOFASICA M210
433014	USO HERRERIA LIVIANA MONOFAS. M250



CARACTERISTICAS	MOD T205	MOD M210	MOD M250
ALIMENTACION	3 x 380 V	1 x 220 V	1 x 220 V
POTENCIA	6Kw	4,5Kw	8Kw
CORRIENTE MAXIMA	195 A	195 A	235 A
FACTOR DE SERVICIO	60% - 140 A	60% - 120 A	60% - 150 A
TENSION EN VACIO	32 V	32 V	36 V
PUNTOS REGULACION	8	8	8
DIAMETRO ALAMBRE	0,6/ 0,9	0,6/ 0,9	0,6/ 0,9
ALTO ANCHO PROF EN CM	75 x 33 x 76	75 x 33 x 76	80 x 36 x 81

**SOPORTE CHASIS**

435001	Soporte chasis 2000K chico
435002	Soporte chasis 4000K mediano
435003	Soporte chasis 8000K grande



**SUPLEMENTOS PARA ALINEACION**

437001	Fiat de 3 mm.
437002	Fiat de 2 mm.
437003	Fiat de 1 mm.
437004	Fiat de 0,50 mm.
437006	Ford de 3 mm.
437007	Ford de 2 mm.
437008	Ford de 1 mm.
437009	Ford de 0,50 mm.
437011	Isuzu de 3 mm.
437012	Isuzu de 2 mm.
437013	Isuzu de 1 mm.
437015	Chevy de 3 mm.
437016	Chevy de 2 mm.
437017	Chevy de 1 mm.
437020	Escort/Peugeot de 3 mm.
437021	Escort/Peugeot de 2 mm.
437022	Escort/Peugeot de 1 mm.

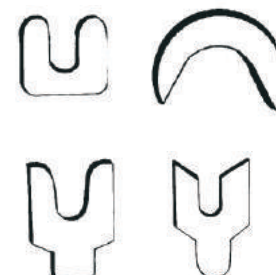

**TALCO**

439001	Talco 1 kilo
439003	Talco bolsa x 25 Kg.



**TANQUE PORTATIL**

440003	Tanque inflado cub./camión SUPER RAPIDO 30 Kg.
440004	Tanque inflado cub./camión SUPER RAPIDO 40 Kg.
440005	Caño salida aire de tanque "Boca de pato"





**CODIGO**
**DESCRIPCION**
**TAPITAS**

441001	Tapitas 200 unidades
441002	Tapitas 1000 unid. plásticas
441005	Tapitas metal hexagonal IMPORTADA

**TELACORD**
**PEDIDO MINIMO EN PAQUETE DE 5 A 7 KG.**

447001	Telacord PIRELLI-FIRESTONE FATE rollo de 5 kg.
447002	Telacord 1ra. calidad importada rollo de 5 kg.

**TERMINALES PARA CAÑOS ESPIRALADOS**

449001	1/4 hierro-hierro 1/4
449003	5/16 hierro-hierro 1/4
449004	3/8 hierro-hierro 1/4
449005	3/8 hierro-hierro 3/8
449006	1/2 hierro-hierro 3/8
449007	1/2 hierro-hierro 1/2
449020	Virolas 1/4 (6,35 mm) y 5/16 (8 mm)
449022	Virolas 3/8 (9,5 mm) y 1/2 (12,7 mm)

**TERRAJAS**

451001	Terraja corta mango plástico
451002	Terraja super larga mango plástico
451003	Terraja corta común metal
451004	Terraja corta super metal 4 funciones
451005	Terraja larga c/brazo cambiabile
451006	Terraja larga con mandril
451007	Terraja extractora mango plástico
451009	Terraja extractora larga de metal
451010	Terraja vial metal

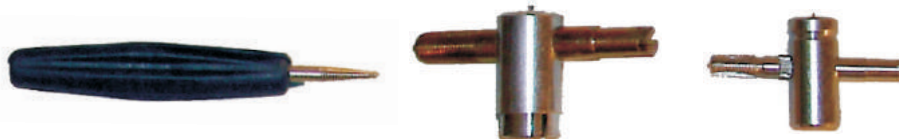
**TIJERAS**

453002	Tijera medio sastre 8" MUNDIAL
453003	Tijera medio sastre 9" MUNDIAL
453004	Tijera 500 x 24 especial gomero MUNDIAL

**TIZAS**

457002	Tizas imborrable x 12 WASSINGTON
--------	----------------------------------

**TRABA CUBIERTA**

458002	Traba p/montaje y desmontaje cubierta s/cámara de aluminio para palanca tipo TNT
--------	----------------------------------------------------------------------------------

**TRAPOS REJILLAS**

459001	Trapo doble 50 x 60 TEPE
459002	Trapo triple 50 x 60 TEPE



**CODIGO**
**DESCRIPCION**
**CODIGO**
**DESCRIPCION**
**TUBOS IMPACTO DE 1/2"**

461001	Impacto 12 a 17mm CORTO	461011	Impacto 12 a 17mm LARGO
461002	Impacto 19mm CORTO	461012	Impacto 19mm LARGO
461003	Impacto 21mm CORTO	461013	Impacto 21mm LARGO
461004	Impacto 22/23mm CORTO	461014	Impacto 23mm LARGO
461005	Impacto 24mm CORTO	461015	Impacto 24mm LARGO
461006	Impacto 27mm CORTO	461016	Impacto 27mm LARGO
461007	Impacto 30mm CORTO		
461008	Adaptador 1/2 a 3/4		
461009	Adaptador 3/4 a 1/2		
461010	Prolongador 1/2		

**TUBOS IMPACTO DE 3/4"**

461100	Impacto 13/16- 21mm. CORTO	461110	Impacto 13/16- 21mm. LARGO
461101	Impacto 15/16- 24mm. CORTO	461111	Impacto 15/16- 24mm. LARGO
461102	Impacto 11/16- 27mm. CORTO	461112	Impacto 1 1/16- 27mm. LARGO
461103	Impacto 13/16- 30mm. CORTO	461113	Impacto 1 3/16- 30mm. LARGO
461104	Impacto 1 1/4- 32mm. CORTO	461114	Impacto 1 1/4- 32mm. LARGO
461105	Impacto 1 5/16- 33mm. CORTO	461115	Impacto 1 5/16- 33mm. LARGO
461106	Impacto 1 1/2- 38mm. CORTO	461116	Impacto 1 1/2- 38mm. LARGO
461107	Impacto 1 5/8- 41mm. CORTO	461117	Impacto 1 5/8- 41mm. LARGO
461108	Prolongador 3/4		
461109	Adaptador 3/4 a 1		

**TUBOS IMPACTO DE 1"**

461200	Impacto 13/16-21mm. CORTO	461210	Impacto 13/16- 21mm. LARGO
461201	Impacto 15/16-24mm. CORTO	461211	Impacto 15/16- 24mm. LARGO
461202	Impacto 11/16-27mm. CORTO	461212	Impacto 11/16- 27mm. LARGO
461203	Impacto 13/16-30mm. CORTO	461213	Impacto 1 3/16- 30mm. LARGO
461204	Impacto 1 1/4-32mm. CORTO	461214	Impacto 1 1/4- 32mm. LARGO
461205	Impacto 1 5/16-33mm. CORTO	461215	Impacto 1 5/16- 33mm. LARGO
461206	Impacto 1 1/2-38mm. CORTO	461216	Impacto 1 1/2- 38mm. LARGO
461207	Impacto 1 5/8-41mm. CORTO	461217	Impacto 1 5/8- 41mm. LARGO
461208	Prolongador 1"		
461209	Adaptador 1" a 3/4		

**VALVULAS MOTO - COCHE - CAMIONETA Y CAMION de BRONCE con y sin PLAQUET p/CUBIERTA c/CAMARA**

463001	TR-1004 MOTONETA
463002	TR-1005 MOTO
463003	TR-1022 MOTO
463004	TR-5785 CAMION
463005	TR-5789 CAMIONETA
463006	TR-F 350 CAMIONETA
463007	TR-9202 900 x 20 CAMION
463008	TR-5790 100 x 20 CAMION
463010	TR-13 COCHE
463011	TR-15 COCHE
463012	TR-51 MOTO
463013	TR-150 GOMA (FORD 350)

**VALVULAS CAMION DE BRONCE PARA CUBIERTA CON CAMARA**

463015	TR-78 TIPO MICHELIN LARGA
463016	TR-78 BASE DE GOMA MICHELIN
463017	TR-78 ARANDELA MICHELIN
463018	TR-75 TIPO MICHELIN CORTA
463019	TR-1221 TIPO PIPA

**VALVULAS BICICLETAS**

463025	Válvula bicicleta completa DUNLOP
463026	Válvula bicicleta con ovulo REGINA
463027	Válvula bicicleta con ovulo LEGNANO
463028	Gomines x 300 unidades



CODIGO

DESCRIPCION

**VALVULAS SCOOTER - COCHE - CAMIONETA DE GOMA PARA CUBIERTA SIN CAMARA**

463038	TR-1702 COMPET. NIQUE S/CAMARA
463039	TR-1702 30 mm. (416) S/CAMARA NIQUELADA
463040	VALVULA INVISIBLE PARA LLANTA DEPORTIVA
463041	ADAPTADOR PARA INFLAR VALVULA INSIVIBLE
463042	VALVULA 6008 VCA RECTA CROMADA
463043	VALVULA 6008 A 90° CROMADA
463050	TR-412 MOTO CON INTERIOR
463051	TR-413 AUTO CON INTERIOR
463052	TR-414 AUTO CON INTERIOR
463053	TR-415 AUTO CON INTERIOR
463054	TR-418 AUTO CON INTERIOR
463055	TR-425 AUTO CON INTERIOR
463060	TR-413 AUTO CON CAPUCHON METAL Y TAPITA
463061	TR-414 AUTO CON CAPUCHON METAL Y TAPITA
463062	TR-415 AUTO CON CAPUCHON METAL Y TAPITA
463063	TR-418 AUTO CON CAPUCHON METAL Y TAPITA
463064	TR-413 SCOOTER CON INTERIOR



**VALVULAS CAMIONETA - CAMION - COLECTIVO**

463070	ALCOA ROSCA 22 mm. CURVA CROMADA
463071	ALCOA ROSCA 22 mm. RECTA CROMADA
463072	TR-571 RECTA SIN CAMARA CORTA 85 mm.
463073	TR-561 CURVA SIN CAMARA CORTA 85 mm.
463074	TR-572 RECTA SIN CAMARA LARGA 96 mm.
463075	TR-642 CURVA SIN CAMARA LARGA 110 mm.
463076	TR-W1390 CURVA CORTA SIN CAMARA PICKUP



**VALVULA DE TRACTOR**

463080	TR-9251 C BASE METAL CON Ch3
463081	TR-9251 V REPUESTO CH1
463083	TR-218 COMPLETA CON CH3 BASE DE GOMA
463084	TR REPUESTO CH3
463085	TR-5880 VALVULA CON CH3 METAL S/CAMARA (618A)

**REPUESTOS**

463092	ADAPTADOR VALVULA VIAL DE 24 mm.
463093	CALOCADORA VALVULA COMUN TIPO T
463094	COLOCADORA VALVULA A PALANCA
463095	MAQUINA CURVAR VALVULAS



**VALVULAS Y REPUESTOS VIALES**

463501	Válvula base hexagonal J670
463510	Válvula base hexagonal s/o y s/t 80 mm. J655
463511	Válvula base hexagonal s/o y s/t 100 mm. J650
463512	Válvula base hexagonal s/o y s/t 120 mm. J651
463513	Válvula base hexagonal s/o y s/t 140 mm. J652
463514	Válvula vial J-4000 80 mm.
463515	Válvula vial J-4000 100 mm.
463516	Válvula vial J-4000 120 mm.
463517	Válvula vial J-4000 140 mm.
463518	Válvula vial curva c/o c/t J1175 para cámara
463519	Válvula vial recta J.1175 1.50 mm. para cámara
463520	Adaptador vial 19 mm. tipo tapa y (sin tapa común)
463521	Adaptador vial 35 mm.
463522	Base válvula J-4000
463525	Adaptador válvula vial para vejiga 48 mm.

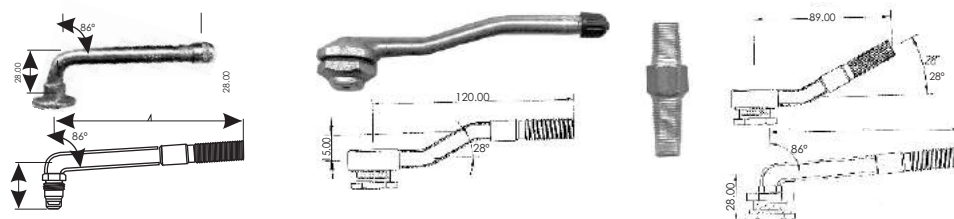
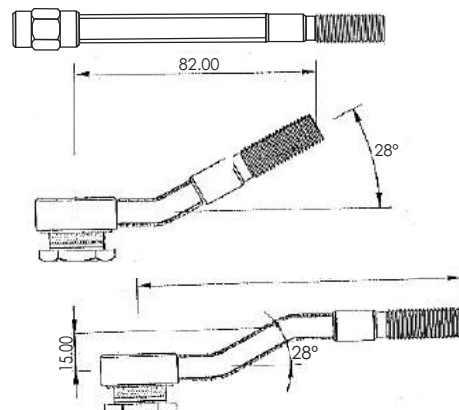

**VALVULAS ENVELOPE**

463530	Válvula para envelope 28 mm.
463531	Adaptador para Válvula envelope 28 mm.



**CODIGO**

**DESCRIPCION**

**VULCANIZACION SAFETY SEAL**

467001	Kit auto - camión Safety
467005	Lube super sello tipo Safety
467007	Lezna coche-camión c/empuñadura aluminio tipo Safety
467008	Aguja coche-camión c/empuñadura aluminio tipo Safety
467011	Lezna c/empuñadura plástico
467012	Aguja c/empuñadura plástico
467013	Sello coche extra Seal 50 unidades
467014	Sello camión extra Seal 25 unidades
467015	Cono p/empuñadura de aluminio (cono solo)
467016	AGUJA AUTO-CAMION TIPO SAFETY IMPORTADA
467017	AGUJA AUTO-CAMION TIPO SAFETY IND. ARGENTINA



**VULCANIZADORAS**

469002	Vulcanizadora 1 brazo económica
469003	Vulcanizadora 2 brazos económica
469005	Vulcanizadora Super Reforzada 1 brazo JIT
469006	Vulcanizadora Super Reforzada 2 brazos JIT
469007	Vulcanizadora COMBI COCHE
469008	Vulcanizadora COMBI CAMION
469026	Volante para vulcanizadora
469028	Cono 1 y 2 brazos
469030	Interruptor p/vulcanizadora
469031	Foquito neón
469032	Termostato
469033	Prensa parche chica
469034	Prensa parche grande
469037	Matriz combi-coche
469038	Matriz combi-camión

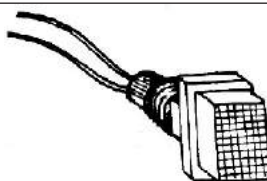

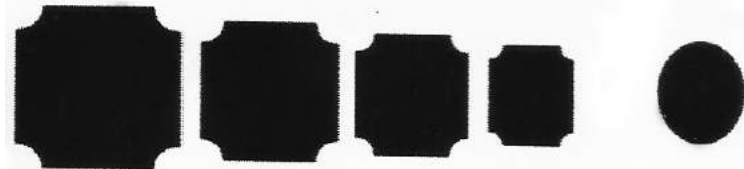

## LOS CLASICOS MANCHONES PARA REPARACION DE NEUMATICOS, ENCOJINADOS FLUX PARA APLICAR CON FLUX

CODIGO	DESCRIPCION	FORMATO	Cant. TELAS	UNIDADES
472001	RC-2	Redondo 50 mm.	2	20
472002	RC-3	Redondo 70 mm.	2	10
472003	RC-4	Redondo 90 mm.	2	10
472004	RC-5	Redondo 100 mm.	2	10
472005	RC-6	Redondo 120 mm.	2	10
472006	RC-10	Cuadrado 125 x 125 mm.	2	10
472007	RC-11	Cuadrado 125 x 125 mm.	4	10
472008	RC-12	Cuadrado 145 x 145 mm.	2	10
472009	RC-13	Cuadrado 145 x 145 mm.	4	10
472010	RC-14	Cuadrado 175 x 175 mm.	2	10
472011	RC-15	Cuadrado 175 x 175 mm.	4	10
472012	RC-16	Cuadrado 210 x 210 mm.	4	6
472013	RC-17	Cuadrado 210 x 210 mm.	6	6
472014	RC-18	Cuadrado 250 x 250 mm.	4	6
472015	RC-19	Cuadrado 250 x 250 mm.	6	6
472016	RC-20	Cuadrado 250 x 250 mm.	8	6
472017	RC-21	Cuadrado 330 x 330 mm.	4	6
472018	RC-22	Cuadrado 330 x 330 mm.	6	6
472019	RC-23	Cuadrado 380 x 380 mm.	6	6
472020	RC-24	Cuadrado 380 x 380 mm.	8	6
472021	RC-25	Cuadrado 500 x 500 mm.	4	3
472022	RC-26	Cuadrado 500 x 500 mm.	6	3
472023	RC-27	Cuadrado 500 x 500 mm.	8	3

**PARA REPARAR CAMARAS**

501001	TG-20 REDONDO 20 mm x 135 u.
501002	TG-30 REDONDO 30 mm x 98 u.
501003	TG-40 REDONDO 40 mm x 96 u.
501004	TG-55 REDONDO 55 mm x 40 u.
501005	TG-80 REDONDO 80 mm x 10 u.
501006	TG-100 REDONDO 100 mm x 10 u.
501007	TG-40x20 ovalado 40x20 mm x 98 u.
501008	TG-65x30 ovalado 65x30 mm x 80 u.
501009	TG-75x45 ovalado 75x45 mm x 30 u.
501010	TG-50x100 ovalado 50x100 mm x 30 u.
501011	TG-70x150 ovalado 70x150 mm x 10 u.

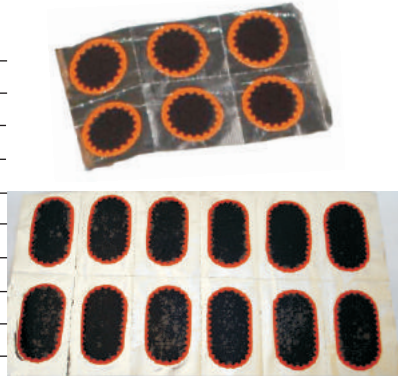
**PARA REPARAR CUBIERTAS**

504000	TGU-30 redondo 30 mm (caja x 80)
504001	TGU-40 redondo 40 mm (caja x60)
504002	TGU-55 redondo 55 mm x 40 unid.
504003	TG1-01 redondo 40 mm x 80 unid.
504004	TG1-02R redondo 55 mm x 40 unid.
504005	TG1-02C 55x55 mm x 40 unid.
504006	TG1-03R redondo 80 mm x 30 unid.
504007	TG2-03R redondo de 80 mm x 20 unid.
504008	TG2-03C 76x76 mm x 20 unid.
504009	TG2-04R redondo 100 mm 15 unid.
504010	TG2-04C 101x101 mm x 15 unid.
504011	TG2-05 127x127 mm x 10 unid.
504012	TG2-06 152x152 mm x 10 unid.
504013	TG2-07 178x178 mm x 10 unid.
504014	TG4-07 178x178 mm x 10 unid.
504015	TG4-08 203x203 mm x 10 unid.
504016	TG4-09 228x228 mm x 10 unid.
504017	TG6-09 228x228 mm x 8 unid.
504018	TG6-11 279x279 mm x 8 unid.
504019	TG8-11 279x279 mm. x 8 unid.
504020	TG8-13 330x330 x 4 unid.
504021	TG8-15 381x381 mm x 4 unid.
504022	TG8-19 482x482 mm x 4 unid.
504023	TG10-13 330x330 mm x 4 unid.

**PARA CUBIERTAS DE TRACTOR**

509001	TG4-11 279x279 mm x 10 unid.
509002	TG6-13 330x330 mm x 4 unid.
509003	TG6-15 381x381 mm x 4 unid.
509004	TG6-19 482x482 mm x 4 unid.

**PARA CUBIERTAS RADIALES AUTO**

517001	RX-1 100x55 mm x 10 unid.
517002	RX-2 150x65 mm x 10 unid.
517003	RX-3 150x75 mm x 10 unid.
517004	RX-4 150x95 mm x 10 unid.
517005	RX-5 180x65 mm x 10 unid.
517006	RX-6 180x75 mm x 10 unid.
517007	RX-7 180x95 mm x 10 unid.





**PARCHES**

**PARA CUBIERTAS RADIALES CAMION**

521001	RX-511A 320x60mm x10 unid.
521002	RX-511 320x120mm x10 unid.
521003	RX-512A 400x60mm x10 unid.
521004	RX-512 400x140mm x10 unid.
521005	RX-521A 110x110mm x 10 unid.
521006	RX-521 150x150mm x 10 unid.
521007	RX-523 200x200mm x 10 unid.
521008	RX-524 260x260mm x 10 unid.



**PLAQUET PARA REPARAR VALVULAS**

526001	P-80 redondo 80mm x 20 unid.
526002	P-100 redondo 100mm x 15 unid.
526003	P-120 redondo 120mm x 10 unid.



**CEMENTO ESPECIAL PARA VULCANIZACION**

531001	C-10 pomo 10cc. x 12 unid.
531002	C-20 pomo 20cc. x 12 unid.
531003	C-250 lata 1/4lt. x unidad
531004	C-500 lata 1/2lt. x unidad
531005	C-1000 lata 1lt. x unidad



**MASILLA AUTOVULCANIZANTE**

535001	Masilla TG x kilo
--------	-------------------



**PARA RADIALES SERIE "TL"**

540001	TL-100 55x55mm x 40 unid.
540002	TL-110 75x55mm x 20 unid.
540003	TL-112 120x70mm x 10 unid.
540004	TL-114 130x85mm x 10 unid.
540005	TL-120 125x80mm x 10 unid.
540006	TL-122 175x75mm x 10 unid.
540007	TL-124 220x75mm x 10 unid.
540008	TL-140 200x115mm x 10 unid.
540009	TL-142 260x130mm x 10 unid.
540010	TL-144 335x130mm x 10 unid.
540011	TL-146 440x180mm x 5 unid.
540012	TL-148 600x220mm x 3 unid.
540013	TL-150 580x180mm x 5 unid.
540014	TL-152 580x240mm x 3 unid.
540015	TL-156 720x270mm x 3 unid.
540016	TL-160 860x270mm x 3 unid.
540017	TL-180 190x150mm x 5 unid.
540018	TL-182 240x185mm x 5 unid.
540019	TL-184 290x210mm x 5 unid.
540020	TL-186 340x245mm x 5 unid.
540030	Lazo L 20 camión x 30 unid. (sin desarme)
540031	Tarugos de 10 cms. x 50 unidades
540032	Combi parche TG 7mm. x 40 unidades



**EQUIPO PARA REPARAR CAMARAS**

554003	S-KIT BICICLETA-COCHE
--------	-----------------------



### PARCHES PARA REPARACION DE CAMARAS ESTRELLADOS

CODIGO	DESCRIPCION	FORMATO	BORDE	UNIDADES	PRECIO
600001	LM 20	Redondo estrellado Ø 20 mm.	NARANJA	150	
600002	LM 30	Redondo estrellado Ø 30 mm.	NARANJA	100	
600003	LM 40	Redondo estrellado Ø 40 mm.	NARANJA	100	
600004	LM 55	Redondo estrellado Ø 55 mm.	NARANJA	40	
600005	LM 40 x 20	Ovalado estrellado 40 x 20 mm.	NARANJA	100	
600006	LM 65 x 30	Ovalado estrellado 65 x 30 mm.	NARANJA	80	
600007	LM 75 x 45	Ovalado estrellado 75 x 45 mm.	NARANJA	30	
600008	LMU 30	Redondo estrellado Ø 30 mm.	GRIS	80	
600009	LMU 40	Redondo estrellado Ø 40 mm.	GRIS	60	
600010	LMU 55	Redondo estrellado Ø 55 mm.	GRIS	34	

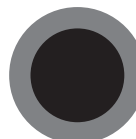

### CEMENTOS EN LATAS

600030	PX-C 250	Lata 1/4 litro	
600031	PX-C 500	Lata 1/2 litro	
600032	PX-C 1000	Lata 1 litro	



### CEMENTOS EN POMO

600050	PX 10 cc	Caja x 12 unidades	
--------	----------	--------------------	--



### PARCHES PARA REPARACION DE CUBIERTAS

600070	PX-1-01	Redondo 40 mm.	AZUL	30	
600071	PX-P AM02 R	Redondo 55 mm.	AZUL	20	
600072	PX-AM02 C	Cuadrado 55 x 55 mm.	AZUL	20	
600073	PX-AM06 A	Cuadrado 65 x 65 mm.	AZUL	50	

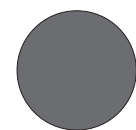

### PLAQUETS DE VALVULAS

600090	PX-P 80	Redondo 80 mm.	GRIS	10	
600091	PX-P 100	Redondo 100 mm.	GRIS	10	
600092	PX-P 120	Redondo 120 mm.	GRIS	10	



### PARCHES RADIALES PARA CUBIERTAS

CODIGO	DESCRIPCION	FORMATO	BORDE	UNIDADES	PRECIO
600120	PXL- 110	Rectangular 75 x 55 mm.	AZUL	10	
600121	PXL- 112	Rectangular 120 x 70 mm.	AZUL	10	
600122	PXL- 114	Rectangular 130 x 85 mm.	AZUL	10	
600123	PXL- 120	Rectangular 125 x 80 mm.	AZUL	10	
600124	PXL- 140	Rectangular 200 x 155 mm.	AZUL	10	
600125	PXL- 142	Rectangular 260 x 130 mm.	GRIS	10	
600126	PXL- 144	Rectangular 335 x 130 mm.	GRIS	10	
600127	PXL- 146	Rectangular 440 x 180 mm.	GRIS	5	
600128	PXL- 152	Rectangular 580 x 240 mm.	GRIS	3	



# FLEX



# NUEVO!!

### LINEA DE PARCHES PARA CUBIERTAS RADIALES más flexibles

600150	PX-2-03	Cuadrado 76 x 76 mm.	GRIS	10	
600151	PX-2-04	Cuadrado 101 x 101 mm.	GRIS	10	
600152	PX-2-05	Cuadrado 127 x 127 mm.	GRIS	10	
600153	PX-2-06	Cuadrado 152 x 152 mm.	GRIS	10	
600154	PX-2-07	Cuadrado 178 x 178 mm.	GRIS	10	
600155	PX-4-07	Cuadrado 178 x 178 mm.	GRIS	10	
600156	PX-4-08	Cuadrado 203 x 203 mm.	GRIS	10	
600157	PX-4-09	Cuadrado 228 x 228 mm.	GRIS	10	
600158	PX-6-09	Cuadrado 228 x 228 mm.	GRIS	10	
600159	PX-6-11	Cuadrado 279 x 279 mm.	GRIS	8	
600160	PX-8-13	Cuadrado 330 x 330 mm.	GRIS	4	
600161	PX-8-15	Cuadrado 380 x 380 mm.	GRIS	4	
600162	PX-8-19	Cuadrado 480 x 480 mm.	GRIS	4	
600163	PXL-110	Rectangular 75 x 55 mm.	NEGRO	10	
600164	PXL-112	Rectangular 120 x 70 mm.	NEGRO	10	
600165	PXL-114	Rectangular 130 x 85 mm.	GRIS	10	
600166	PXL-120	Rectangular 125 x 80 mm.	GRIS	10	
600167	PXL-140	Rectangular 200 x 115 mm.	GRIS	10	
600168	PXL-142	Rectangular 260 x 130 mm.	GRIS	10	
600169	PXL-144	Rectangular 335 x 130 mm.	GRIS	10	



# HERRAMIENTAS ESPECIALES

**Corrector de comba**  
cod. 310/25 de 1mm. FORD  
F100 mod. 94 cm. adelante

Cod. 471206

**Corrector de comba**  
cod. 311/25 de 1 1/2 mm. FORD  
F100 mod. 94 cm. adelante

Cod. 471207

**Corrector de comba**  
cod. 312/25 de 2mm. FORD  
F100 mod. 94 cm. adelante

Cod. 471208



**Corrector de combas**  
**universal MC. PHERSON**

Cod. 471001

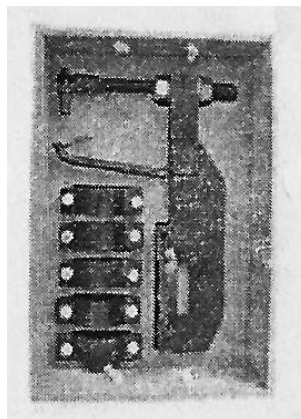

Cod. 345

**Corrector de combas**  
**Línea VW**

Cod. 471002

Cod. 345 W

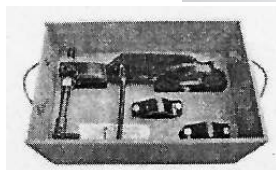

**Tubo de 4 puntas para**  
**tuerca de rótula inferior**



Cod. 471005



003: PEUGEOT

**Tubo de 2 puntas para**  
**tapón de grasa de rótula**



Cod. 471010



004: PEUGEOT

**Punzón para extracción**  
**de espina de elásticos de**  
**semi eje. Diámetro 5mm.**

Cod. 471015



014: RENAULT  
014T

**Extractor de bujes**  
**SILENT BLOCK**



Cod. 471017

**MAQUIN PARTS**

**Tubo para bujía**  
**Universal con pasador**



Cod. 471018

111 B:

**Extractor de brazo**  
**Pitman Blazer y S10**



Cod. 471020  
509:

**Extractor de rulemanes**  
**alternadores y dinamos**



Cod. 471025

233:

**Extractor de tapa de**  
**alternadores**



Cod. 471027

319:

**Extractor poleas**  
**cigüeñal**



Cod. 471030  
106:

**Extractor de volante**  
**Vectra Meriva 00**



Cod. 471035  
512:

**Comprimidor de**  
**Espirales**



Cod. 471040  
137:  
RENAULT 12

Para cambiar amortiguadores sin desarmar el espiral. Soporte - solo cambia amortiguadores

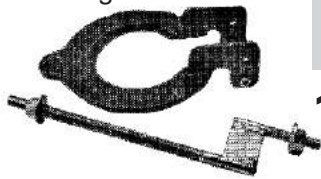

**Compresor de Espirales**

Cod. 471045

137A: RENAULT 12

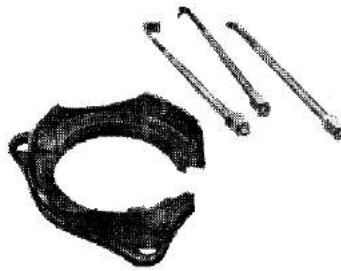

**Compresor de Espirales**

Cod. 471050

137B: RENAULT 18

**Llave para tapa de cilindro Vectra E 16 Tra. Torx H 16**

Cod. 471055  
469:



**Llave para tapa de cilindro Vectra E 16 Tra. Torx H 16**

Cod. 471056  
471P:



**Levanta valvula Universal a cremallera**

Cod. 471060  
282:

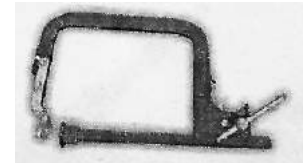

**Traba de volante para motores de VW**

Cod. 471061  
524:



**Centrador embrague Universal**

Cod. 471065  
149A:

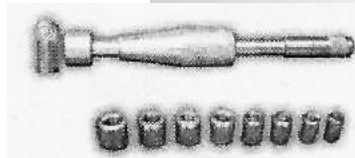

**Extractor de rulemanes y ruedas Pick Up**

Cod. 471070  
145:



**Compresor de Espirales**

Cod. 471075  
169: UNIVERSAL



**Extractor de Extremos de Dirección**

Cod. 471076  
172: UNIVERSAL



**Extractor de Extremos de Dirección Universal**

Cod. 471080  
172B:



**Extractor de brazos Pitman**

Cod. 471085  
184: CHEVROLET  
DODGE



**Extractor de brazos Pitman Universal**

Cod. 471090  
184B:



**Extractor de extremo para auto y camión Forjado**

Cod. 471092  
525C:  
525G:



**Extractor de brazos Pitman Universal**



Cod. 471095  
184F:

**Juego de extractor de bujes ciegos**

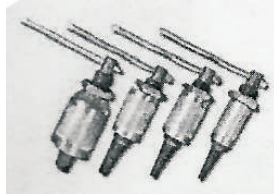

Cod. 471098  
236:

**Extractor a percusión de inyectores Ford Ranger**



Cod. 471100  
508:

**Juego de dados para amortiguadores**



Cod. 471105  
214:

Usados con Art. 214  
Nº1: 4 p/r (Peugeot)  
Nº2: 4 p/c Ø 44,5mm.  
Nº3: 4 p/c Ø 35mm.  
Nº4: 4 p/o Ø 43mm.  
Nº5: 4 p/ Ø 32mm.  
Volkswagen  
Dodge 1500  
Peugeot  
Nº6: Hexa. Ø 29mm.  
Gacel

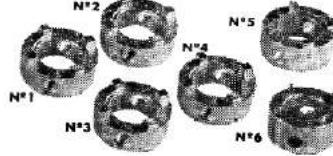

**Dados sueltos**

Cod. 471110  
214:

PEUGEOT  
VOLKSWAGEN  
DODGE 1500  
GACEL

**Extractor de campos Universal**



Cod. 471115  
217:

**Extractor de botadores a percutor**

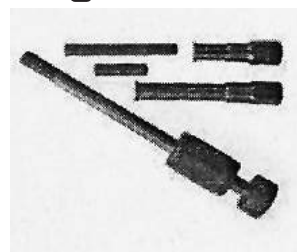

Cod. 471120  
355:

Para los modelos:  
1112 - 1114 - 1517

**Extractor de brazo Pitman**



Cod. 471125

228: MERCEDES BENZ

**Extractor de Rotulas**

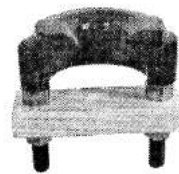

Cod. 471130

241: RENAULT 12

**Extractor y colocador de rodillos Peugeot o de eje trasero**

Cod. 471135  
481P:

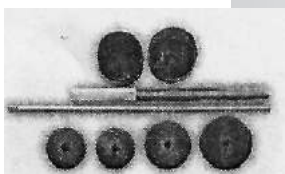

**Extractor pole cigüeñal camión**

Cod. 471136  
269:



**Extractor de Rótulas Universal**



Cod. 471145  
280:

**Extractor de Precap 36mm.**  
Cod. 298-1

Cod. 471146

**Extractor de Precap 38mm.**  
Cod. 298-3

Cod. 471147

**Extractor de Precap 41mm.**  
Cod. 298-2

Cod. 471148



**Extractor de Precap Universal**



Cod. 471149  
**298-6:**

Nuevo sistema de rosca  
**Tubo de 4 puntas para extraer rótulas**



Cod. 471150



**294:** PEUGEOT  
504-505

**Extractor percutor maza R 21**

Cod. 471155  
**335:**



**Comprimidor de espirales para Mac Pherson**



Cod. 471160  
**360:**

**Colocador y extractor de bujes de parrillas**

Cod. 471165  
**410:**



VW - GACEL  
CARAT - GOL  
PASSAT

Nuevo sistema de rosca

**B E**  
mm 1/2" **Tubo de 4 puntas para extraer rótulas**



Cod. 471167

**426:** PEUGEOT  
405

**Extractor de rótula**



Cod. 471168  
**517-41:**  
**517-42:**

PEUGEOT  
307

Para regular altura  
**Extractor y regulador de barra de torsión**



Cod. 471170  
**467:**

PEUGEOT  
206 - 305  
405 - 406

**Regulador de altura Renault**

Cod. 471175  
**468:**



Para regular altura

RENAULT  
9 - 11 - 19 - 21  
CLIO - MEGANE

**Extractor y colocador de rodillos**

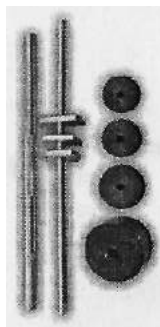

Cod. 471180  
**481:**

De lados interno y externo de ejes traseros

RENAULT  
9 - 11 - 19 - 21  
MEGANE

**Extractor de volantes de dirección**



Cod. 471196  
**195:**

UNIVERSAL

**Comprimidor de espirales Universal Nuevo modelo**



Cod. 471200  
**360N:**

**Extractor hidráulico para Rótulas y brazo Pitman**

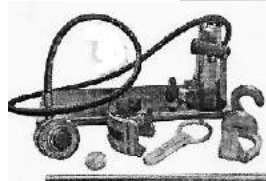

Cod. 471201  
**616:**

**Extractor de brazo Pitman y extremo de dirección**



Cod. 471205  
**551:**